

DOĞRAMA PROFİLLERİ

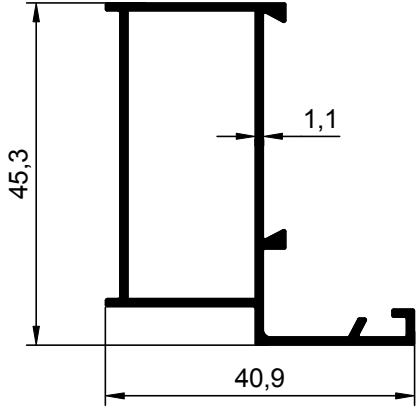

NO : 598
AGIRLIK : 0.482 kg/m

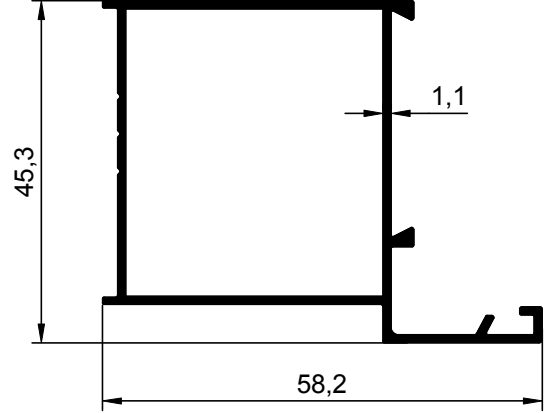

NO : 944
AGIRLIK : 0.583 kg/m

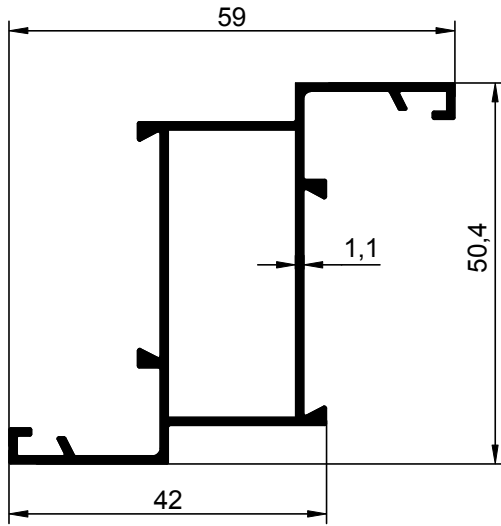

NO : 597
AGIRLIK : 0.602 kg/m

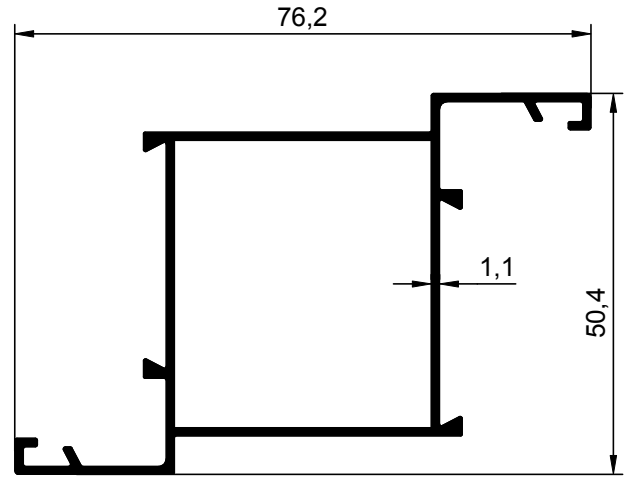

NO : 946
AGIRLIK : 0.705 kg/m

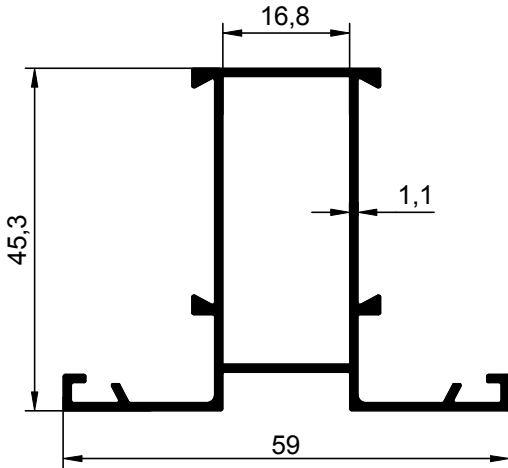

NO : 595
AGIRLIK : 0.602 kg/m

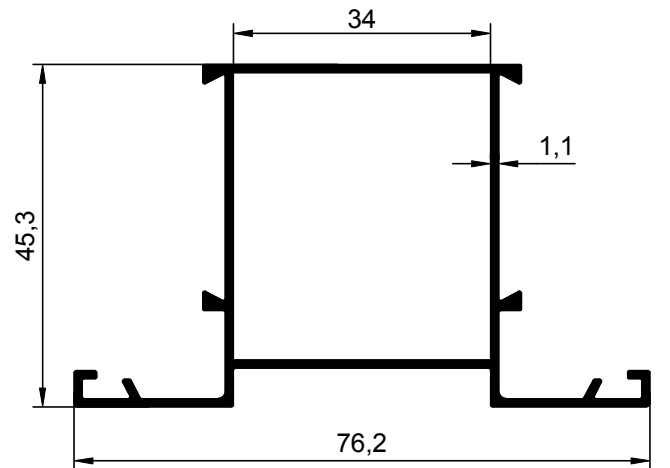

NO : 945
AGIRLIK : 0.705 kg/m

DOĞRAMA PROFİLLERİ

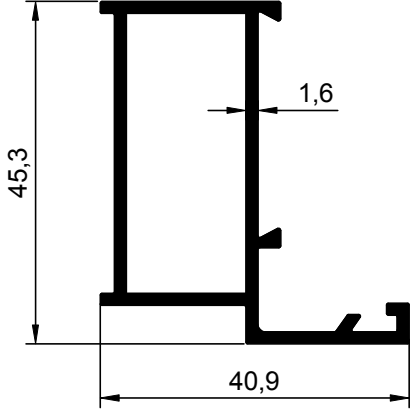

NO : 1205
AGIRLIK : 0.676 kg/m

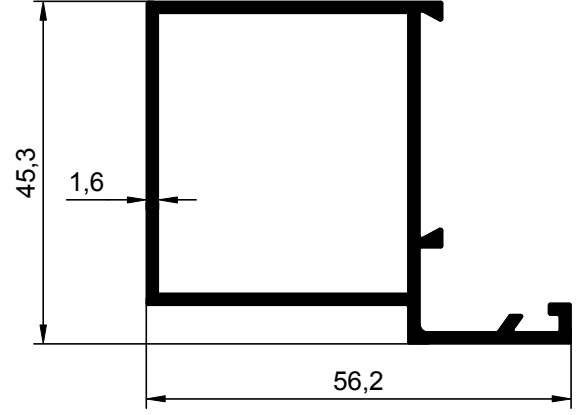

NO : 1182
AGIRLIK : 0.809 kg/m

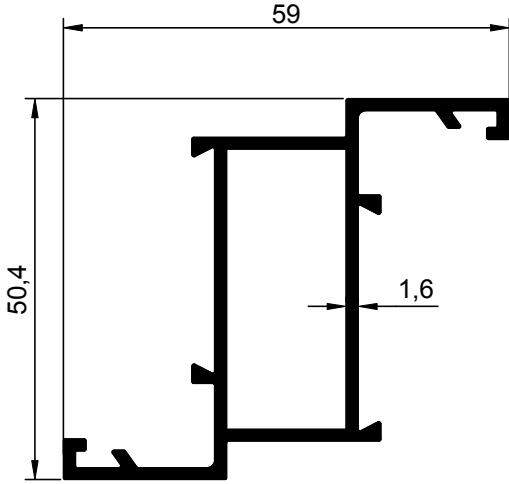

NO : 1204
AGIRLIK : 0.836 kg/m

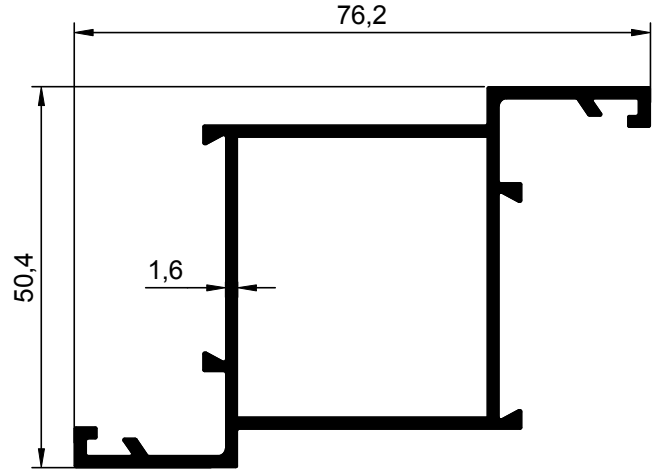

NO : 1183
AGIRLIK : 0.984 kg/m

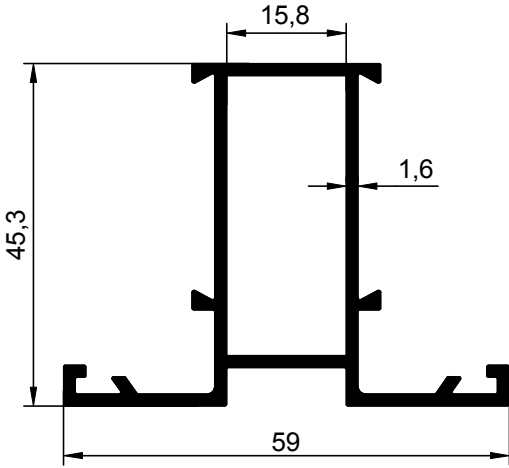

NO : 1203
AGIRLIK : 0.836 kg/m

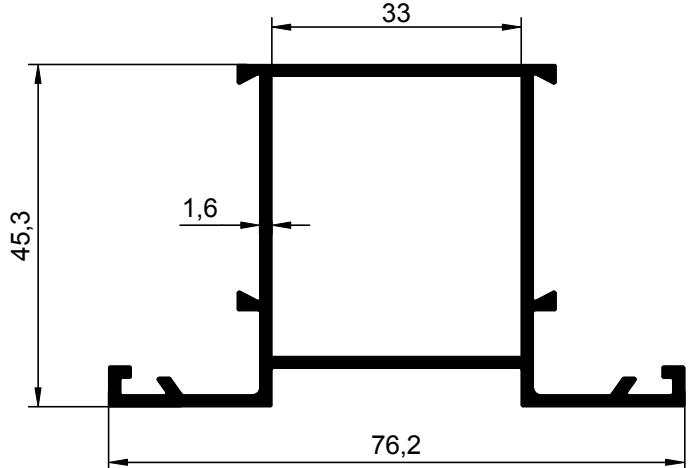

NO : 1181
AGIRLIK : 0.984 kg/m

DOĞRAMA PROFİLLERİ

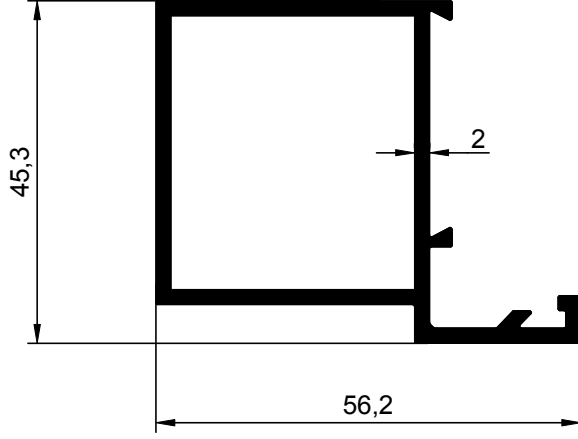

NO : 1785
AGIRLIK : 0.996 kg/m

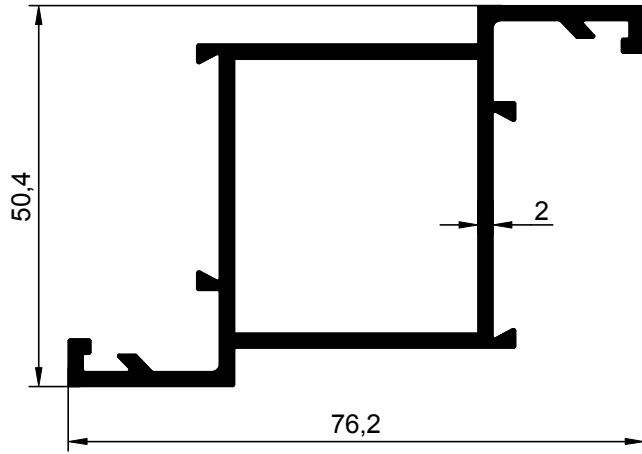

NO : 1787
AGIRLIK : 1.210 kg/m

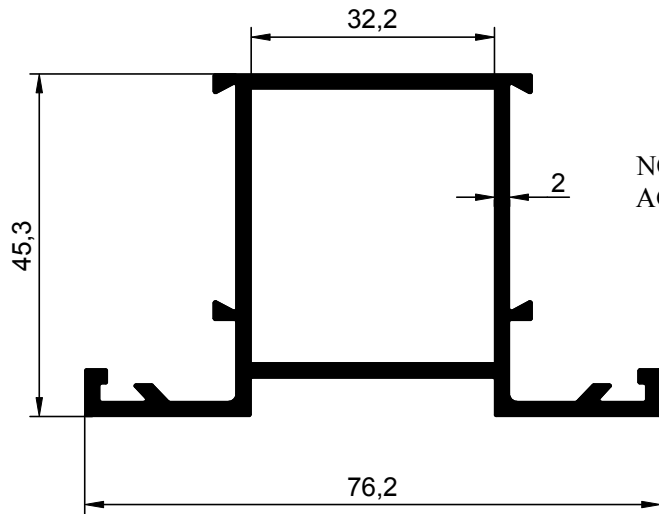

NO : 1786
AGIRLIK : 1.210 kg/m

DOĞRAMA PROFİLLERİ

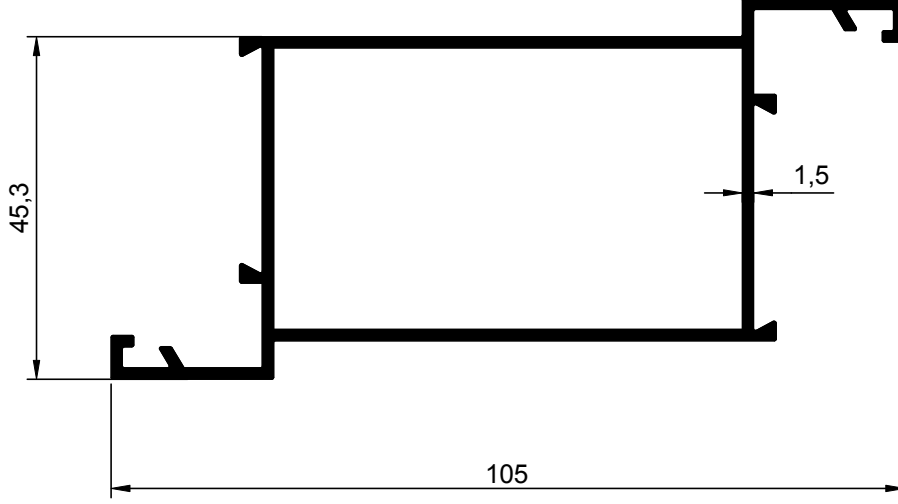

NO : 1545
AGIRLIK : 1.169 kg/m

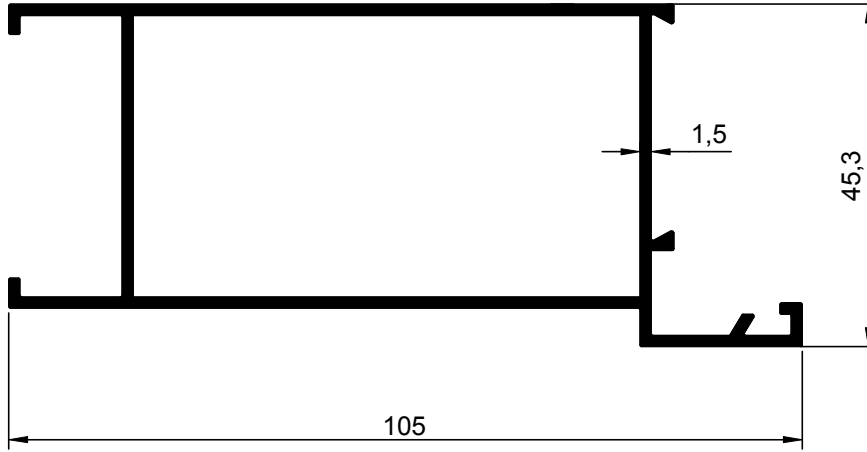

NO : 1222
AGIRLIK : 1.180 kg/m

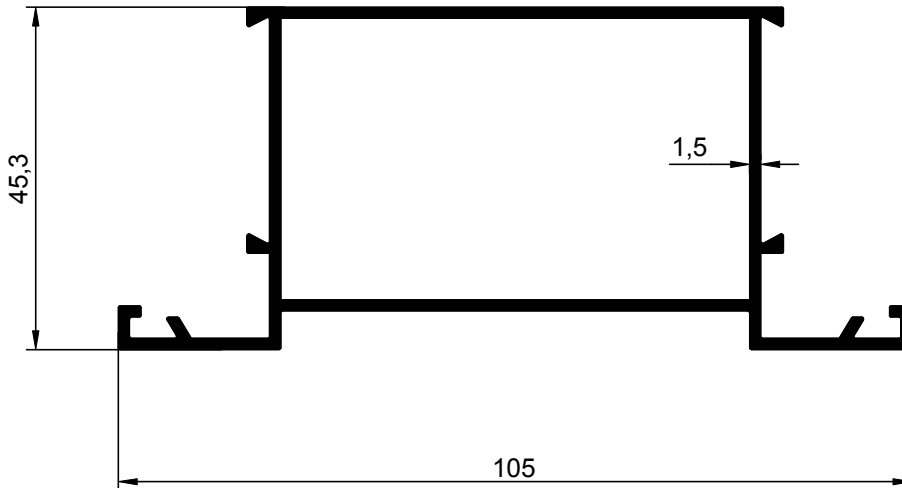

NO : 1240
AGIRLIK : 1.169 kg/m

DOĞRAMA PROFİLLERİ

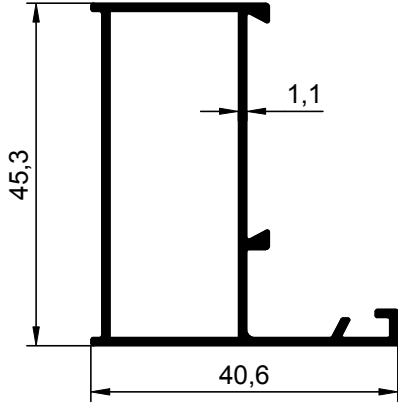

NO : 1344
AGIRLIK : 0.495 kg/m

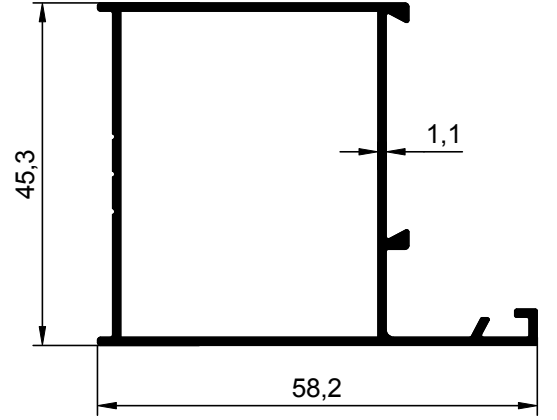

NO : 1347
AGIRLIK : 0.598 kg/m

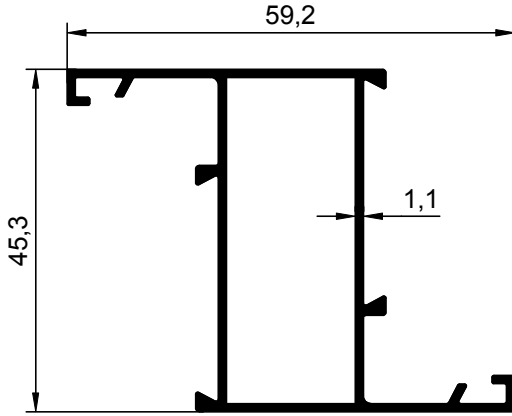

NO : 1346
AGIRLIK : 0.605 kg/m

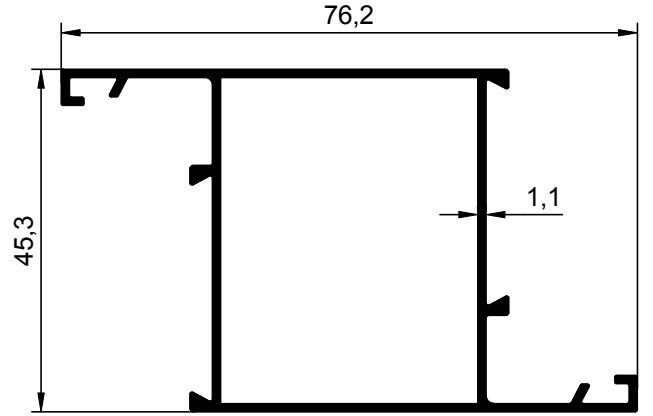

NO : 1349
AGIRLIK : 0.706 kg/m

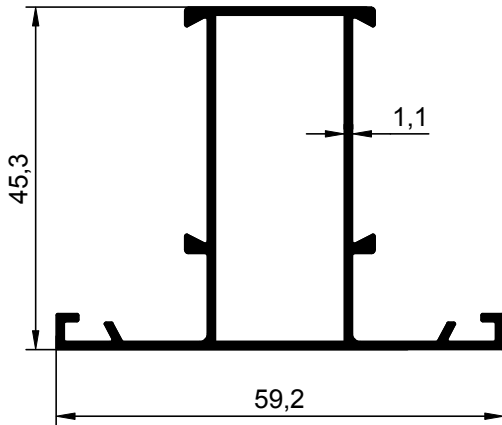

NO : 1345
AGIRLIK : 0.605 kg/m

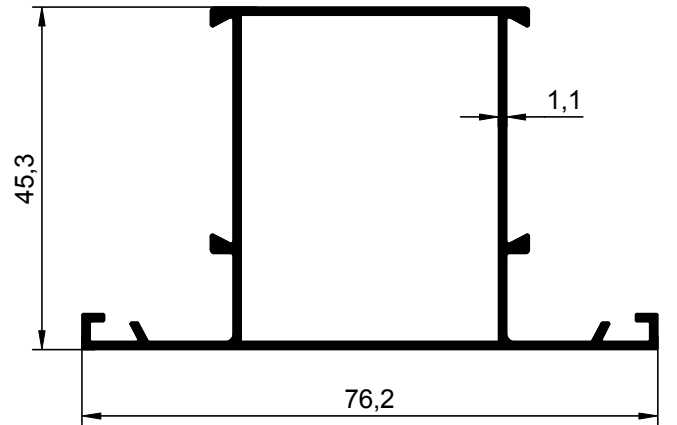

NO : 1348
AGIRLIK : 0.706 kg/m

DOĞRAMA PROFİLLERİ

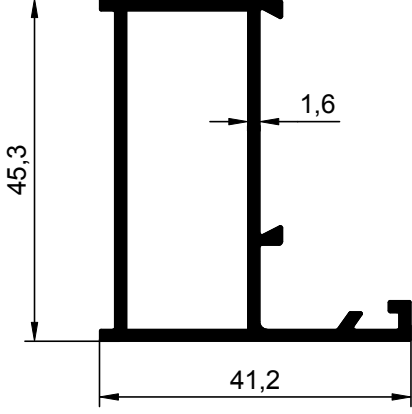

NO : 1711
AGIRLIK : 0.701 kg/m

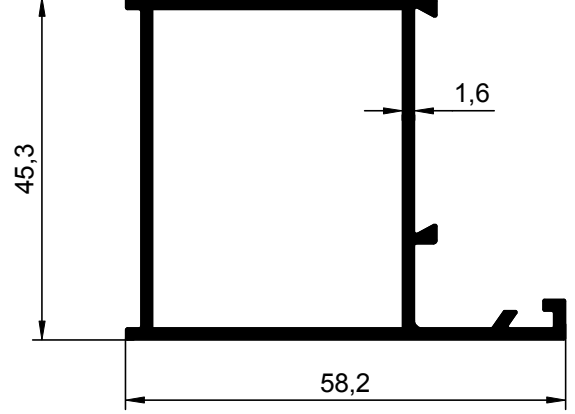

NO : 1577
AGIRLIK : 0.848 kg/m

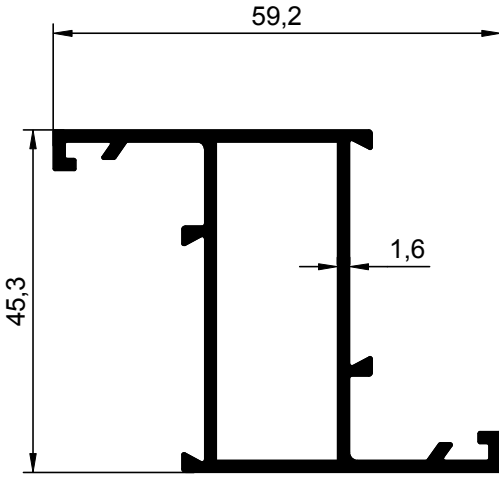

NO : 1139
AGIRLIK : 0.837 kg/m

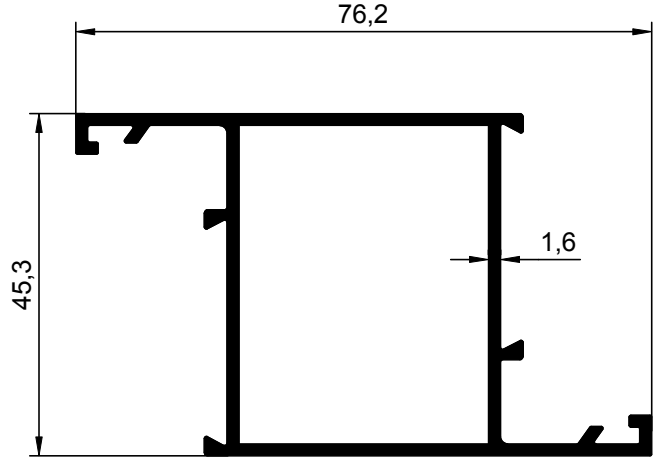

NO : 1579
AGIRLIK : 0.984 kg/m

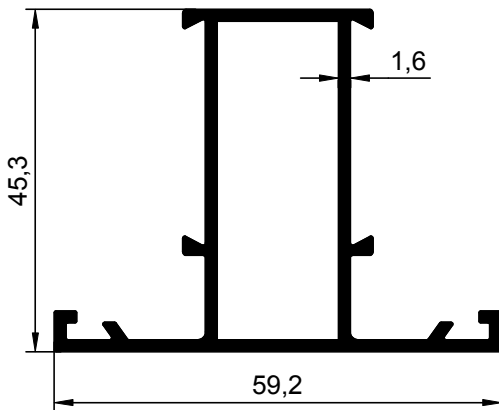

NO : 1140
AGIRLIK : 0.837 kg/m

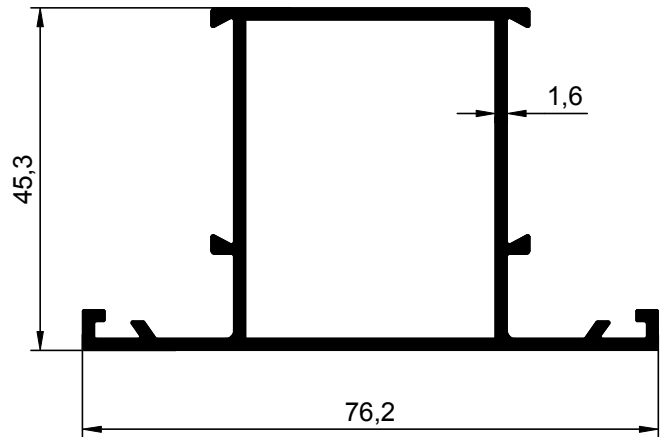

NO : 1578
AGIRLIK : 0.984 kg/m

DOĞRAMA PROFİLLERİ

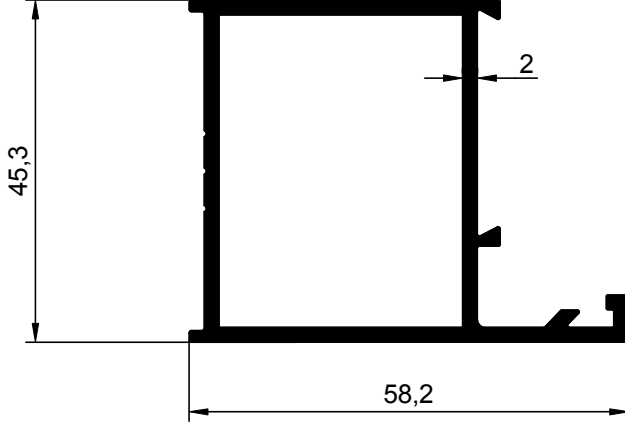

NO : 1400
AGIRLIK : 1.040 kg/m

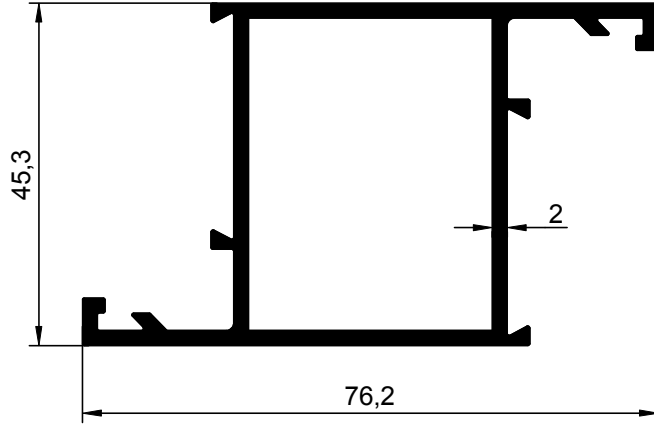

NO : 1401
AGIRLIK : 1.210 kg/m

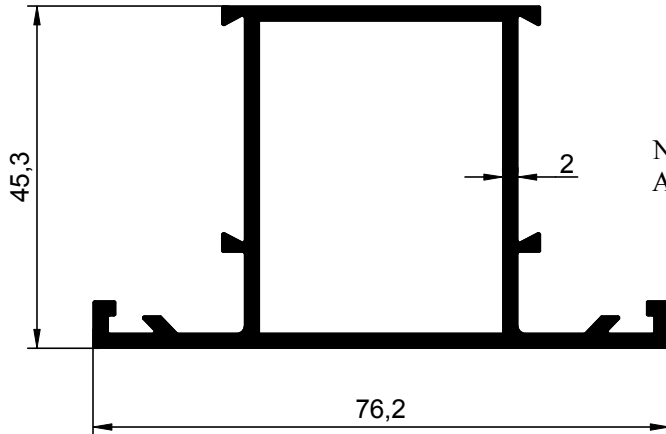

NO : 1402
AGIRLIK : 1.210 kg/m

DOĞRAMA PROFİLLERİ

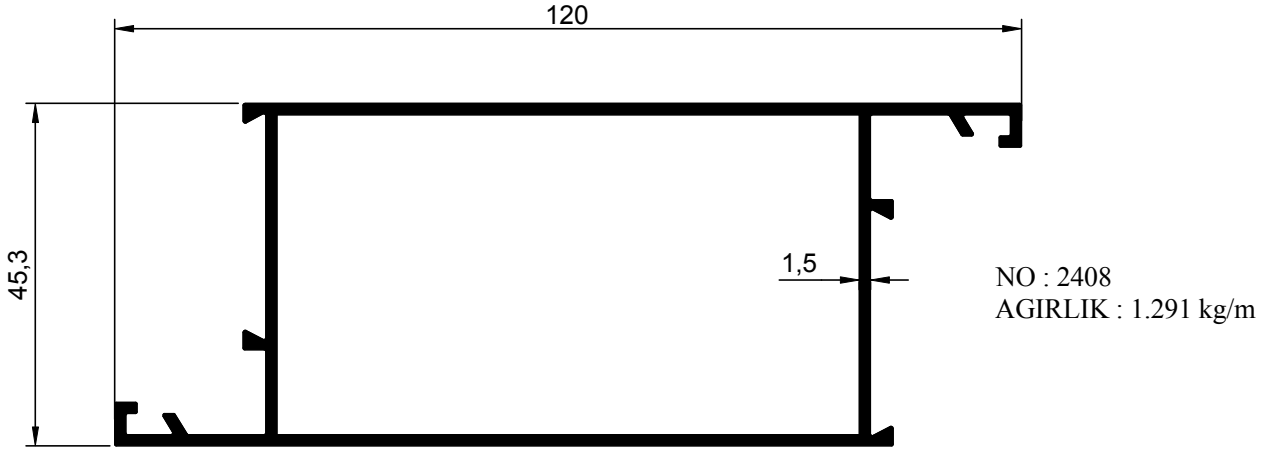
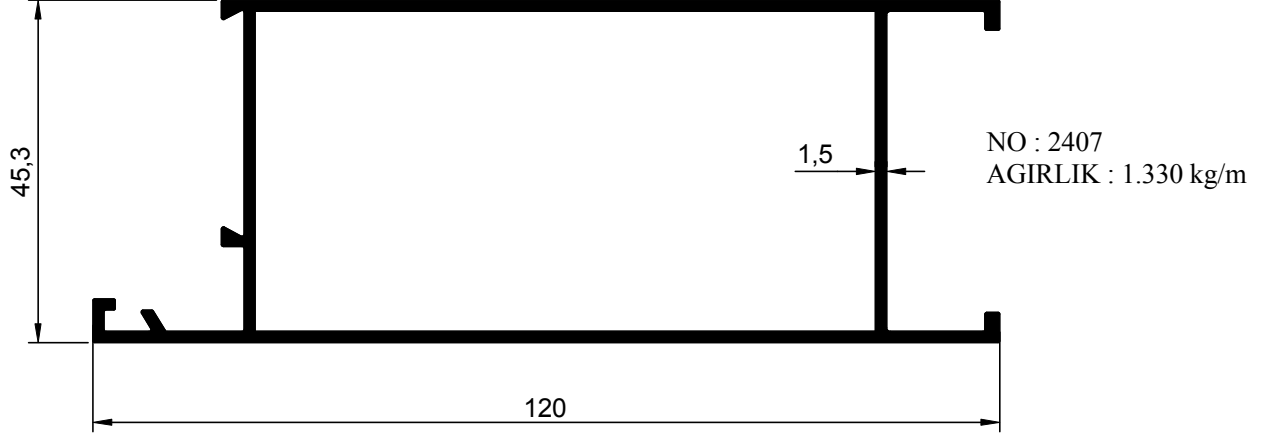

DOĞRAMA PROFİLLERİ

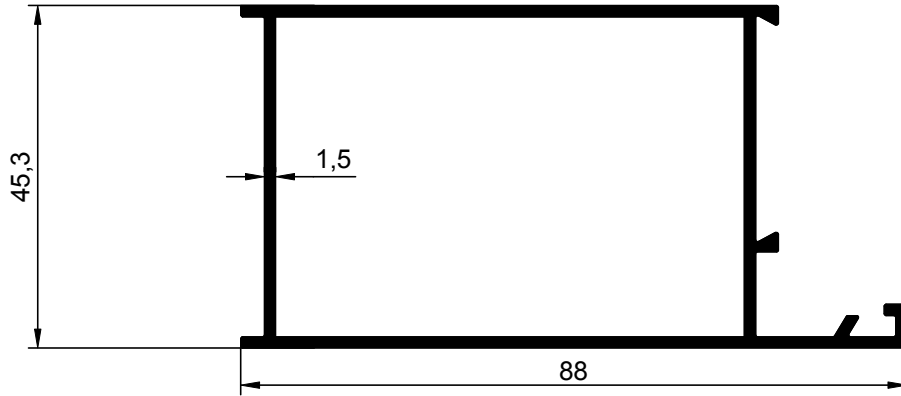

NO : 1959
AGIRLIK : 1.045 kg/m

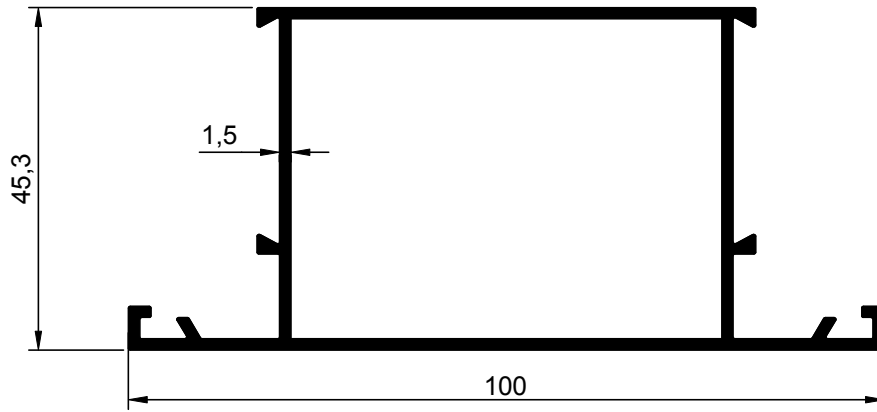

NO : 1542
AGIRLIK : 1.129 kg/m

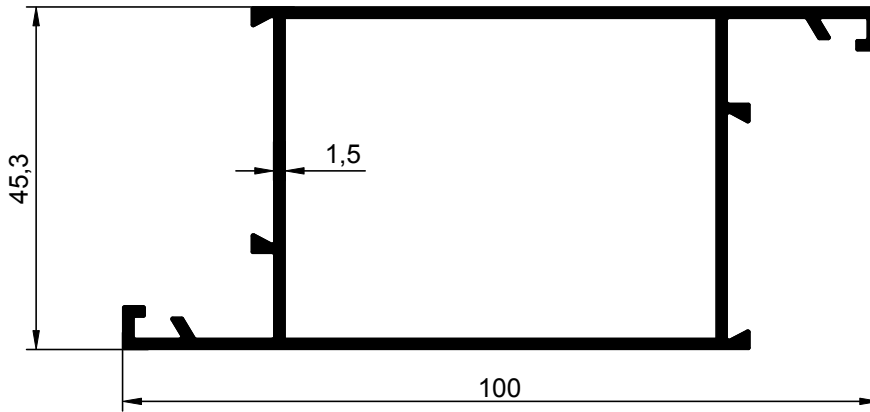

NO : 1543
AGIRLIK : 1.129 kg/m

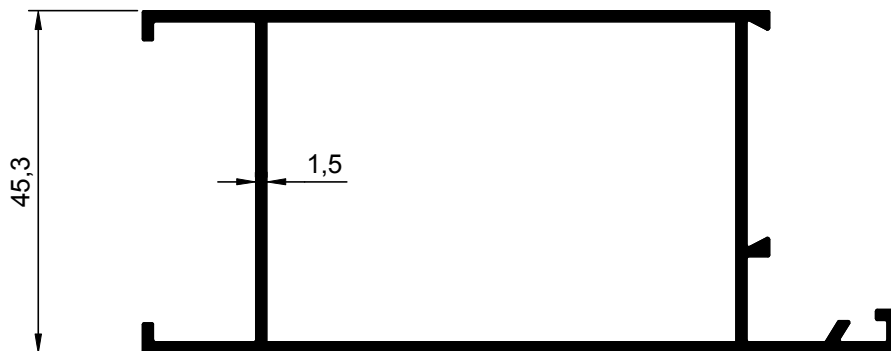

NO : 1544
AGIRLIK : 1.161 kg/m

DOĞRAMA PROFİLLERİ

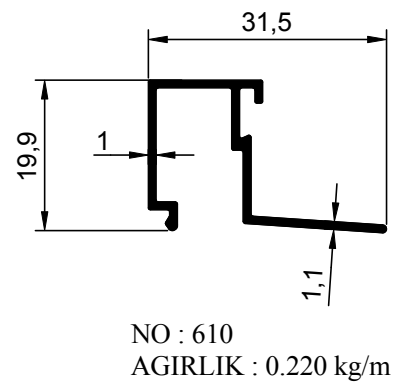
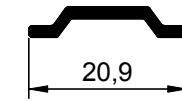
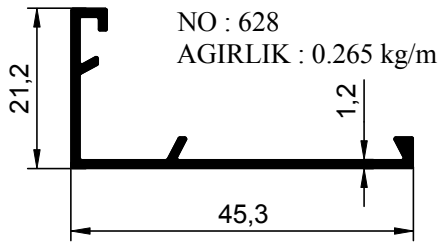
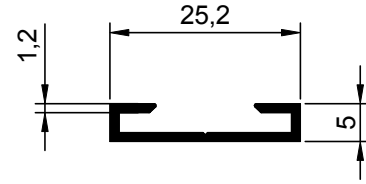
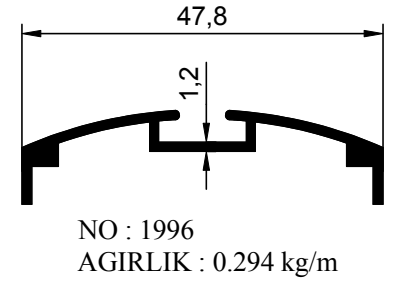
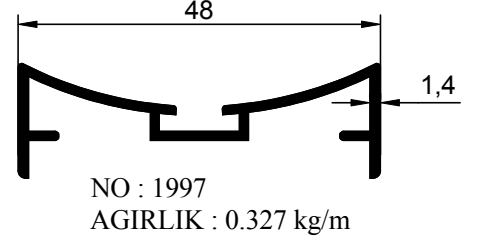
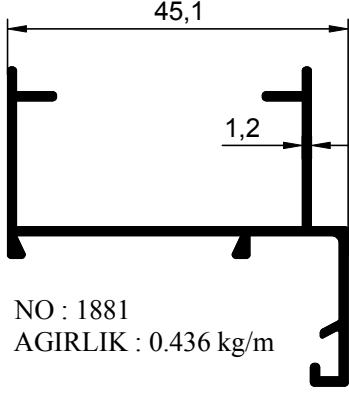

DOĞRAMA PROFİLLERİ

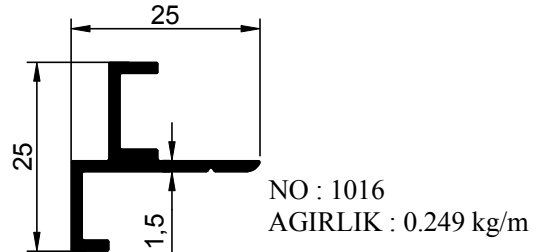
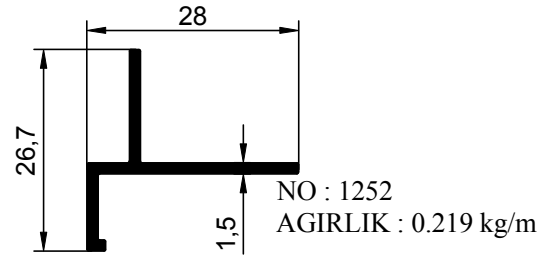
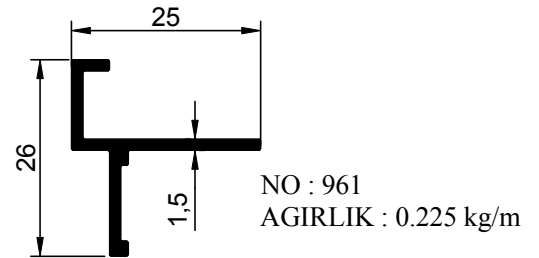
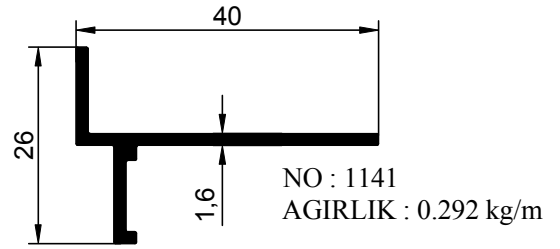
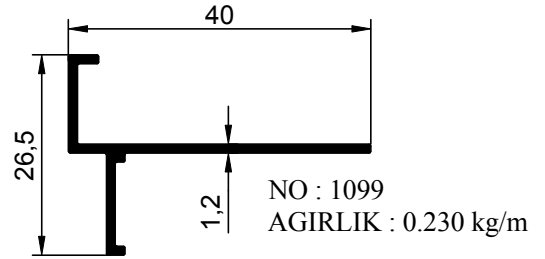
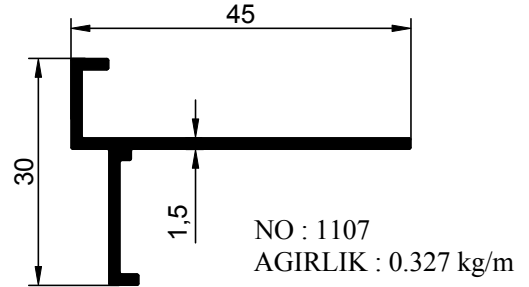
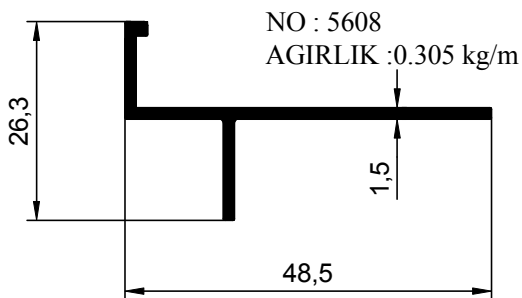
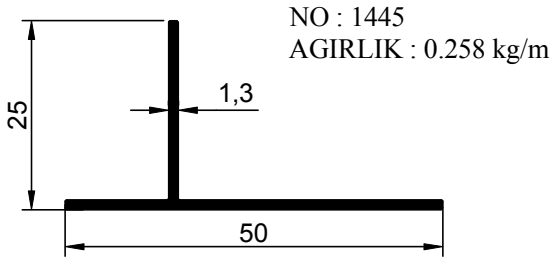
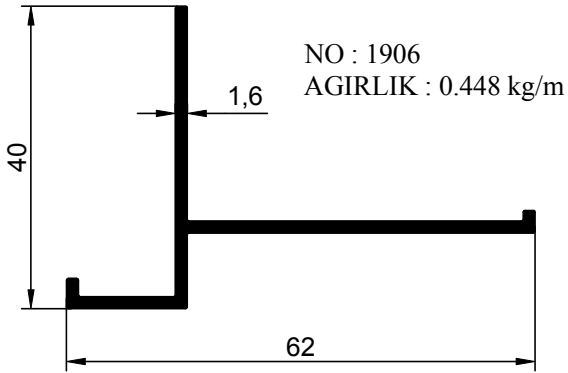
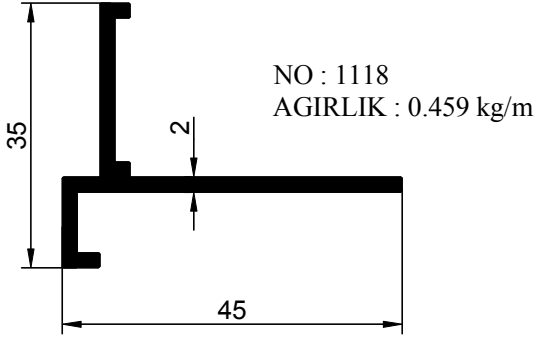

DOĞRAMA PROFİLLERİ

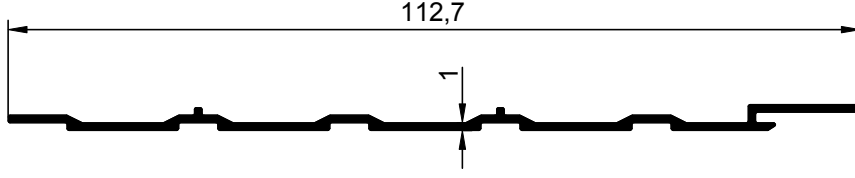

NO : 569
AGIRLIK : 0.347 kg/m

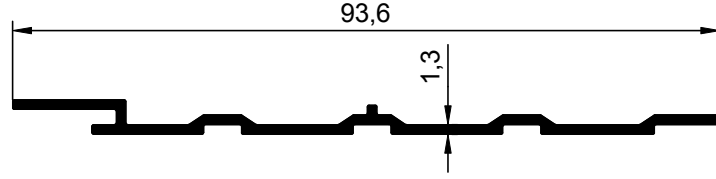

NO : 570
AGIRLIK : 0.376 kg/m

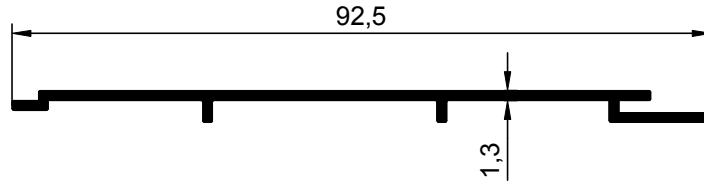

NO : 602
AGIRLIK : 0.373 kg/m

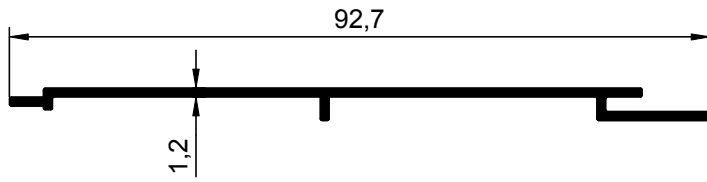

NO : 744
AGIRLIK : 0.342 kg/m

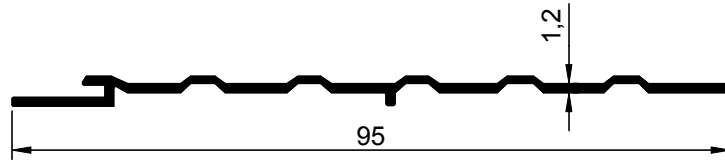

NO : 808
AGIRLIK : 0.319 kg/m

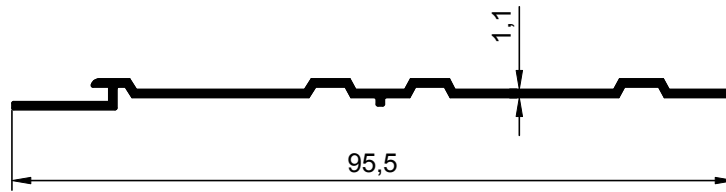

NO : 826
AGIRLIK : 0.319 kg/m

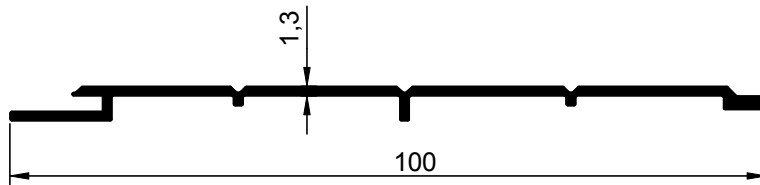

NO : 1090
AGIRLIK : 0.398 kg/m

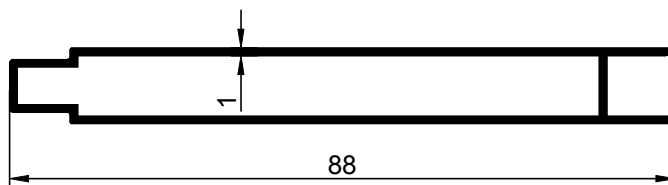

NO : 1045
AGIRLIK : 0.517 kg/m

DOĞRAMA PROFİLLERİ

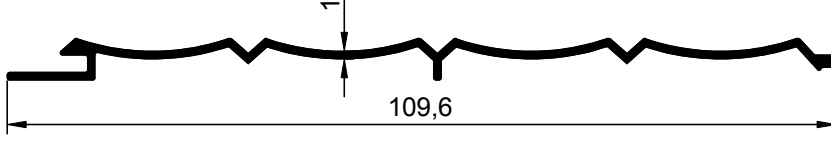

NO : 2679
AGIRLIK : 0.352 kg/m

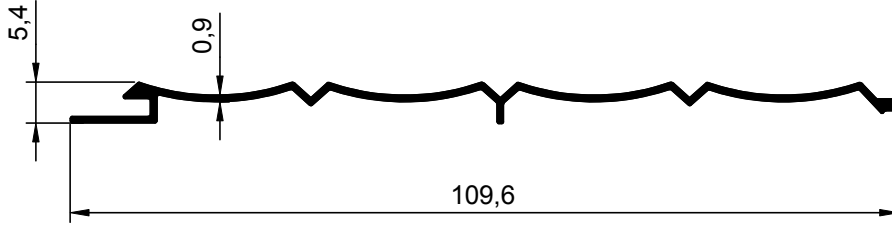

NO : 5434
AGIRLIK : 0.322 kg/m

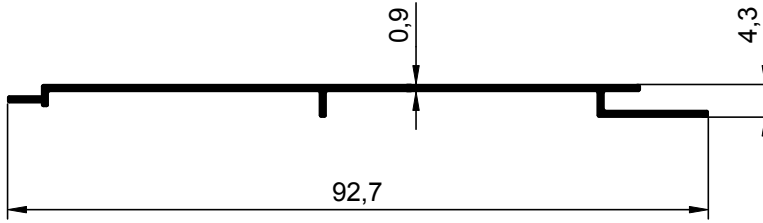

NO : 5430
AGIRLIK : 0.259 kg/m

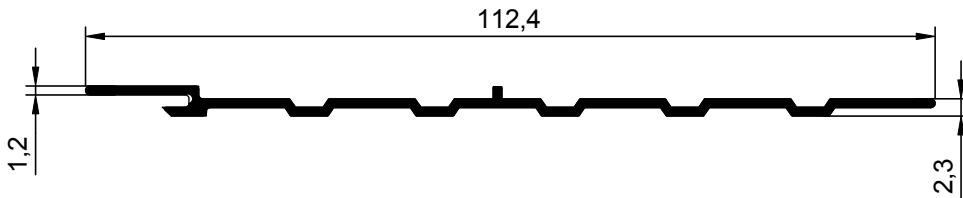

NO : 5428
AGIRLIK : 0.411 kg/m

DOĞRAMA PROFİLLERİ

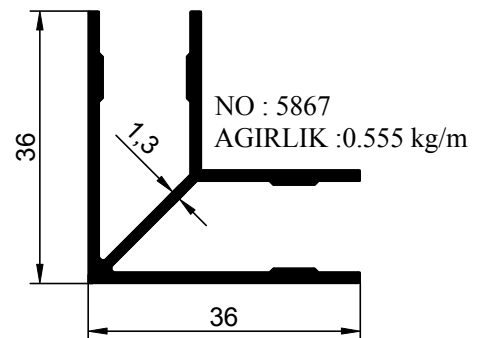
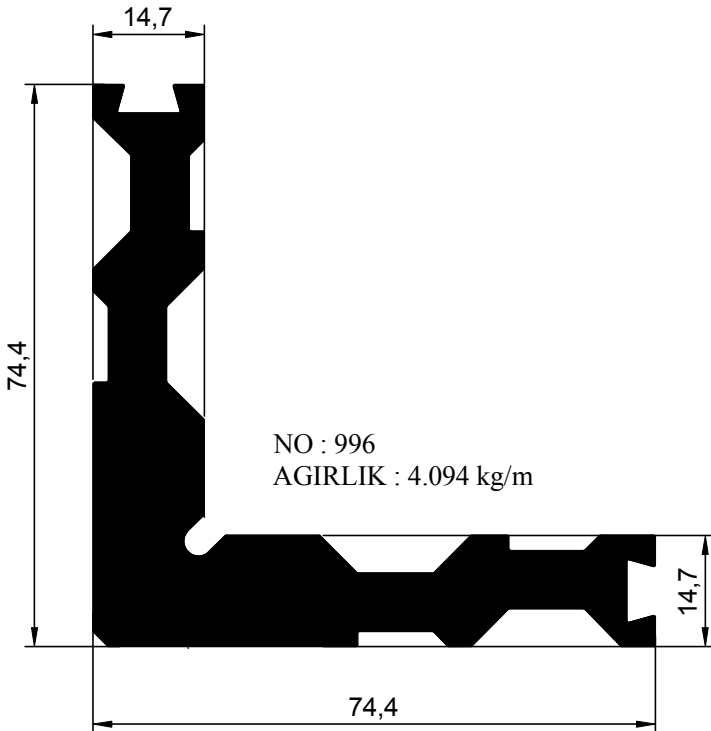
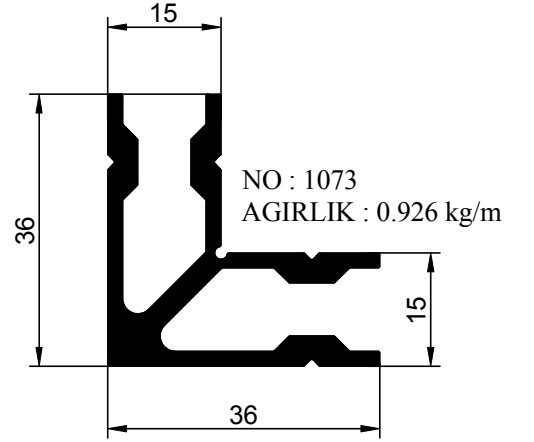
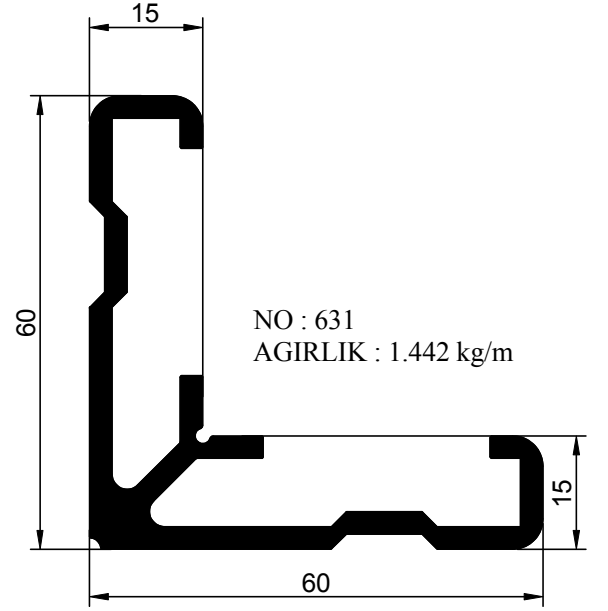
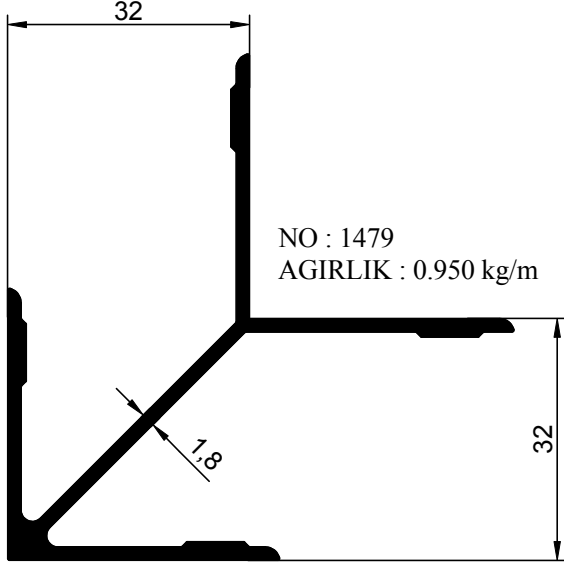

DOĞRAMA PROFİLLERİ

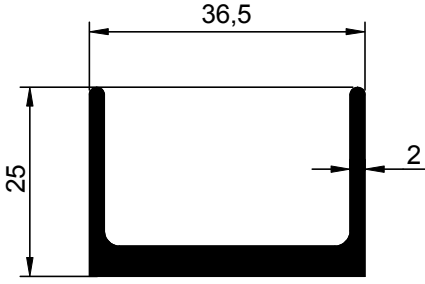

NO : 1050
AGIRLIK : 0.624 kg/m

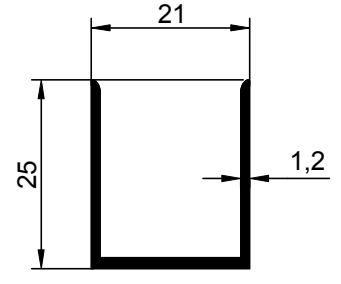

NO : 937
AGIRLIK : 0.235 kg/m

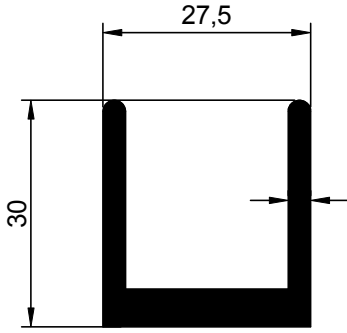

NO : 603
AGIRLIK : 0.770 kg/m

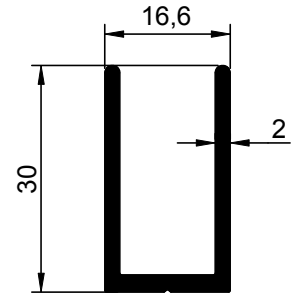

NO : 1395
AGIRLIK : 0.402 kg/m

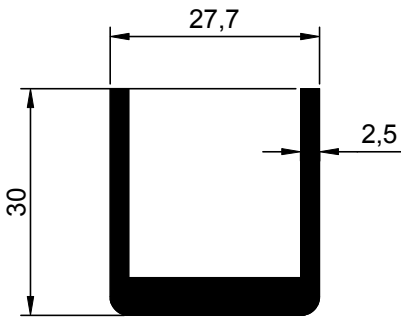

NO : 1133
AGIRLIK : 0.705 kg/m

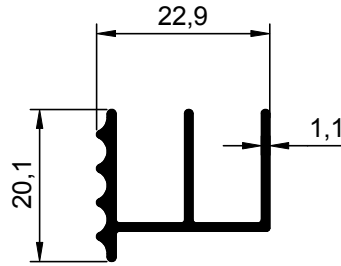

NO : 2678
AGIRLIK : 0.238 kg/m

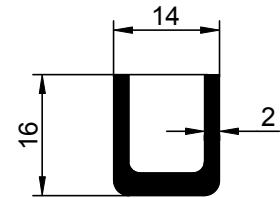

NO : 899
AGIRLIK : 0.251 kg/m

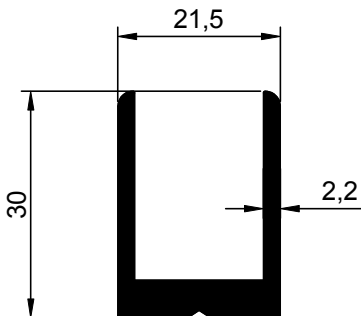

NO : 1443
AGIRLIK : 0.585 kg/m

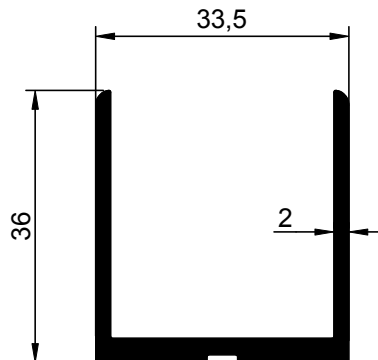

NO : 1396
AGIRLIK : 0.629 kg/m

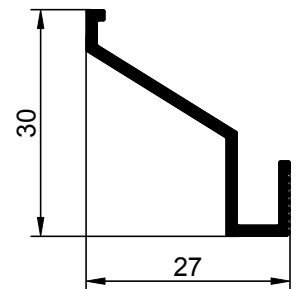

NO : 611
AGIRLIK : 0.225 kg/m

DOĞRAMA PROFİLLERİ

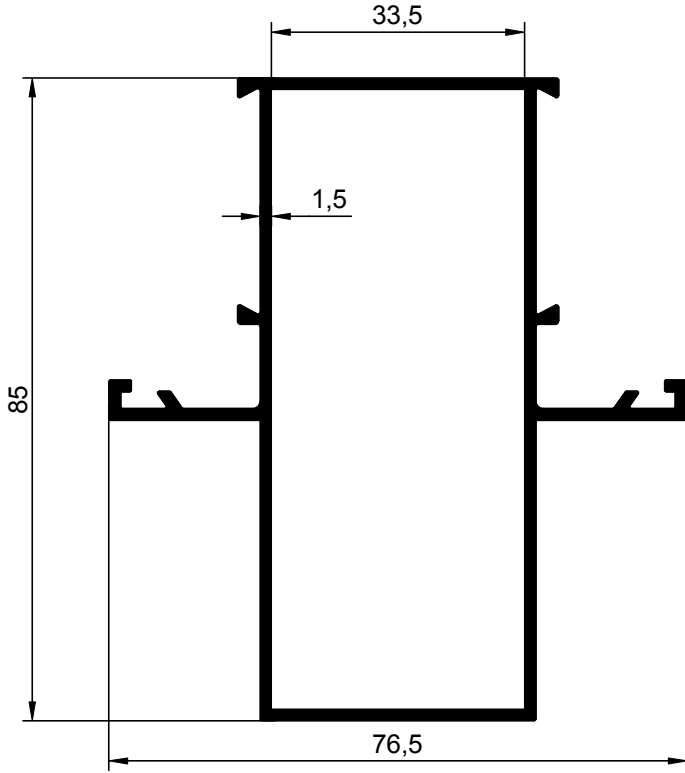

NO : 1122
AGIRLIK : .1.270 kg/m

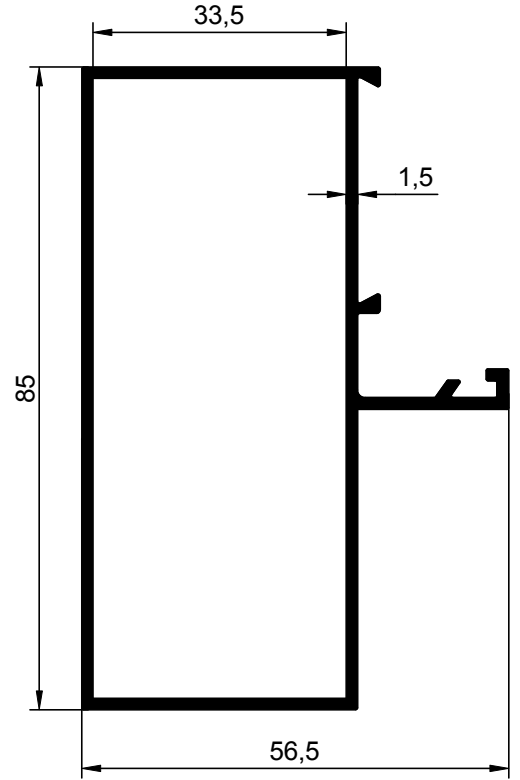

NO : 1407
AGIRLIK : 1.114 kg/m

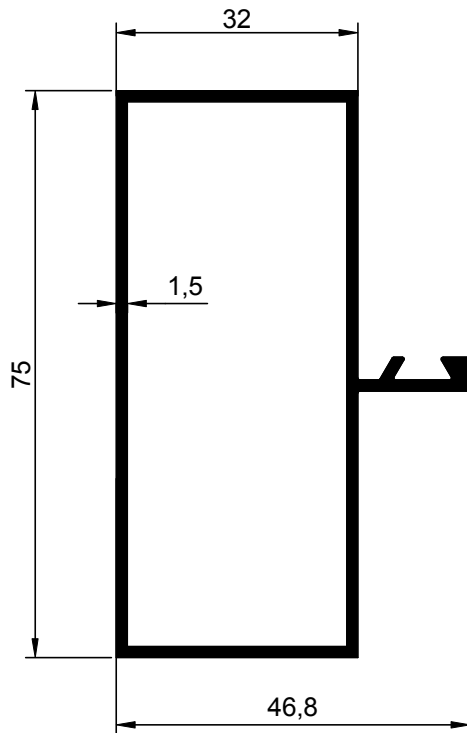

NO : 747
AGIRLIK : 0.941 kg/m

DOĞRAMA PROFİLLERİ

NO : 2035
AGIRLIK : 0.798 kg/m

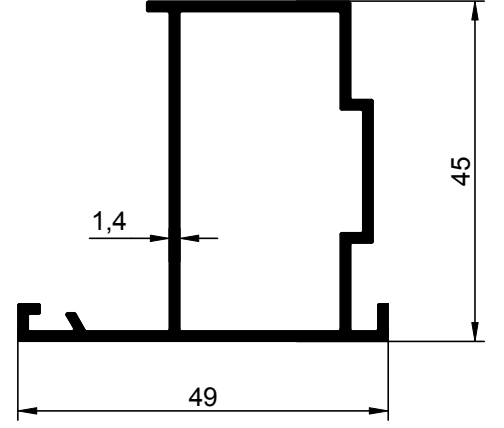
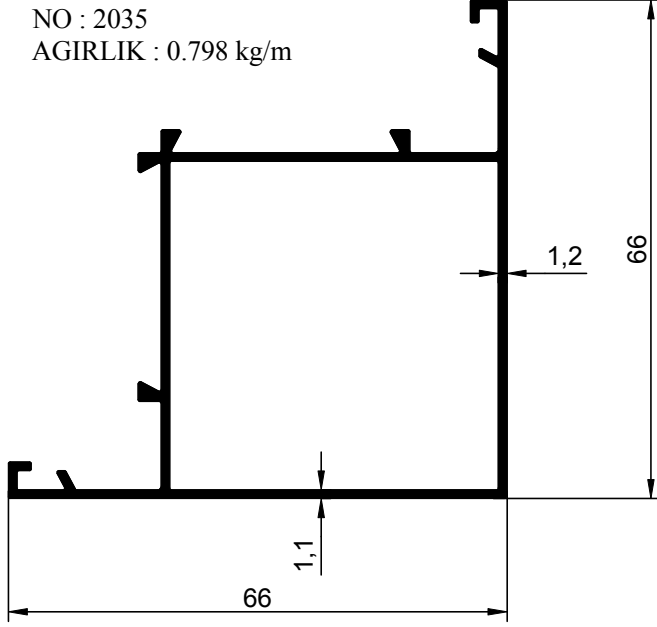

NO : 1070
AGIRLIK : 0.670 kg/m

NO : 1218
AGIRLIK : 0.755 kg/m

