

OTOMOTİK KAPI PROFİLLERİ

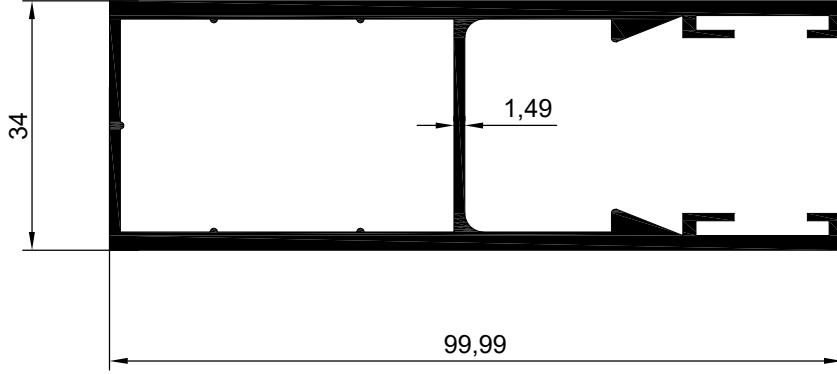

NO : 1649
AGIRLIK : 1.712 kg/m

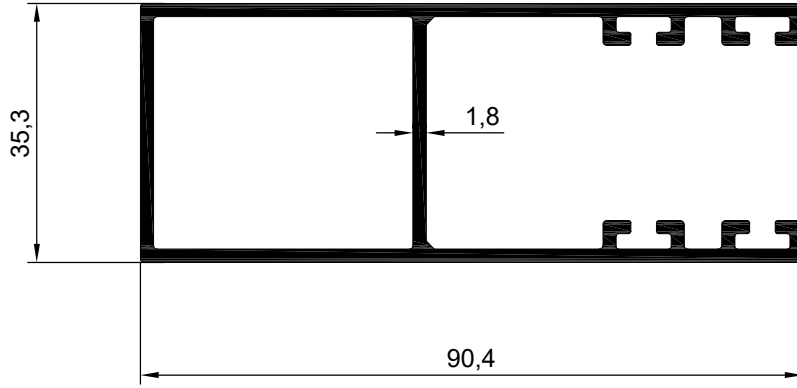

NO : 3089
AGIRLIK : 1.419 kg/m

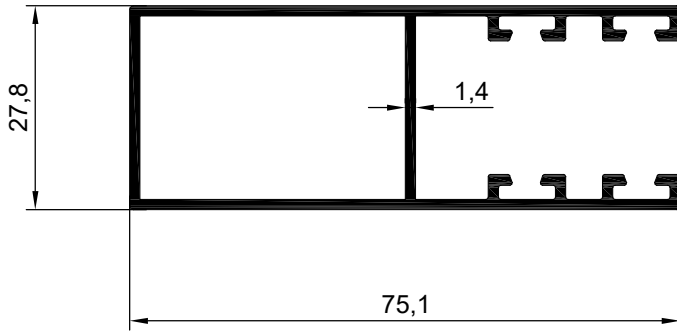

NO : 3088
AGIRLIK : 0,919 kg/m

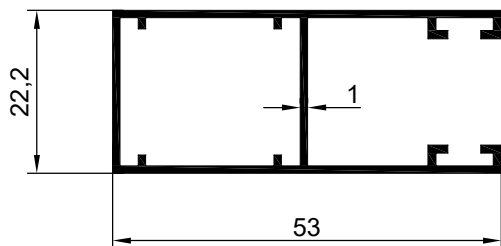

NO : 2169
AGIRLIK : 0,465 kg/m

OTOMOTİK KAPI PROFİLLERİ

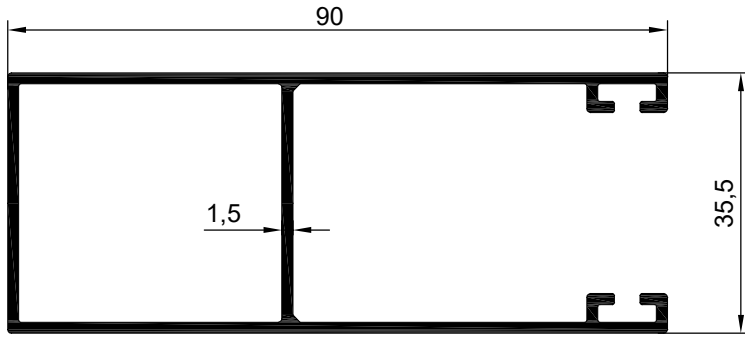

NO : 11255
AGIRLIK : 1.094 kg/m

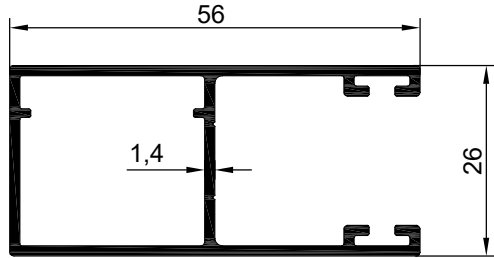

NO : 11256
AGIRLIK : 0.683 kg/m

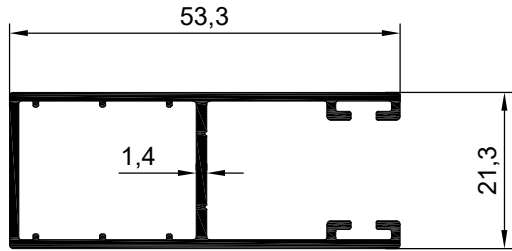

NO : 11257
AGIRLIK : 0.554 kg/m

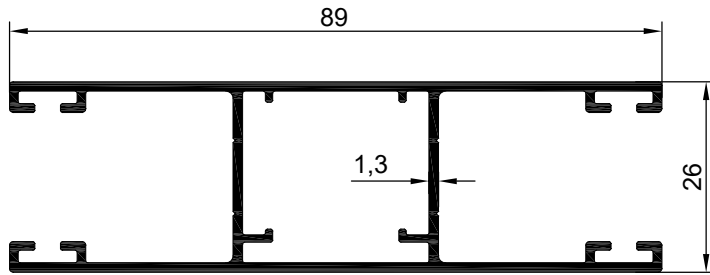

NO : 11260
AGIRLIK : 0.959 kg/m

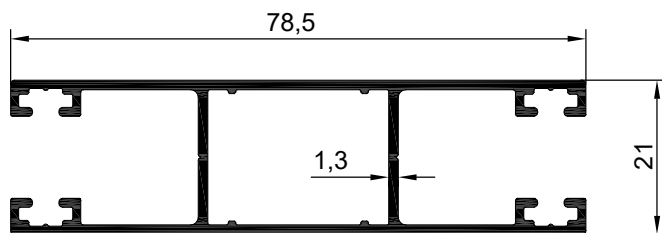

NO : 11261
AGIRLIK : 0.829 kg/m

OTOMOTİK KAPI PROFİLLERİ

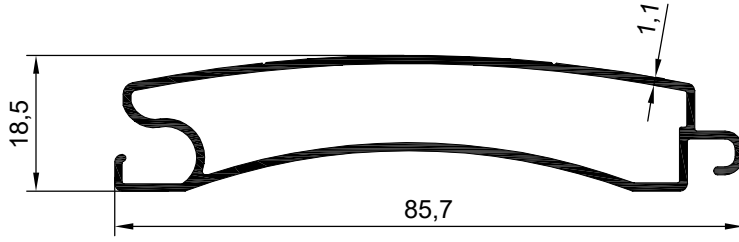

NO : 4074
AGIRLIK : 0,612 kg/m

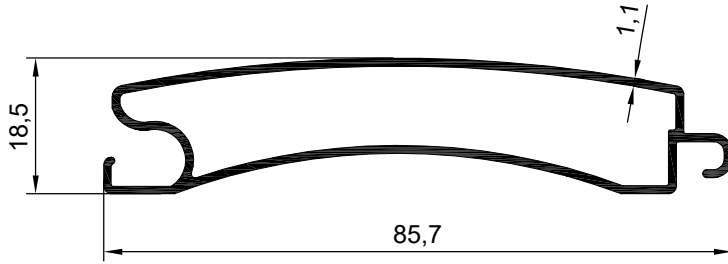

NO : 4075
AGIRLIK : 0,612 kg/m

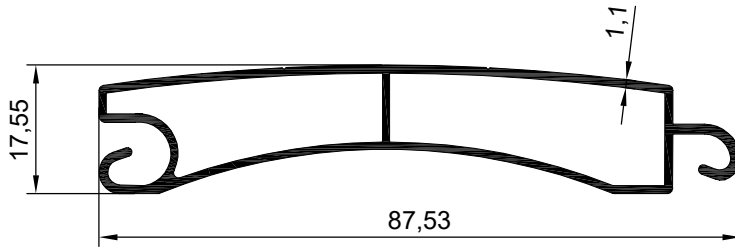

NO : 3303
AGIRLIK : 0,660 kg/m

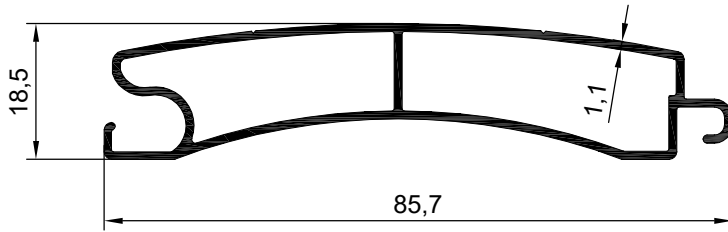

NO : 1634
AGIRLIK : 0,644 kg/m

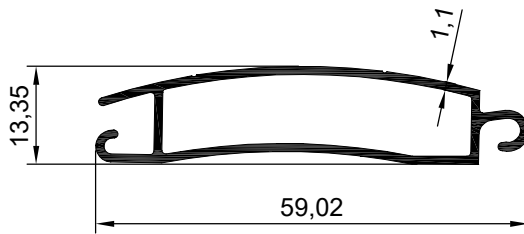

NO : 2101
AGIRLIK : 0,412 kg/m

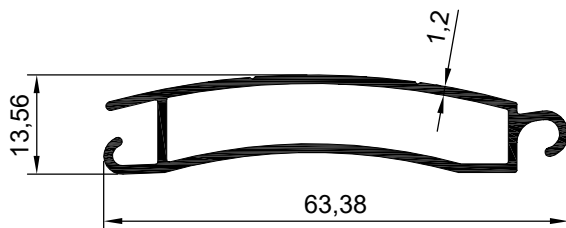

NO : 3302
AGIRLIK : 0,473 kg/m

OTOMOTİK KAPI PROFİLLERİ

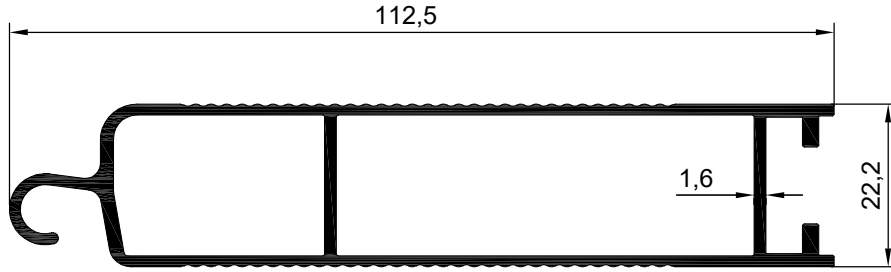

NO : 11668 AGIRLIK : 1,156 kg/m

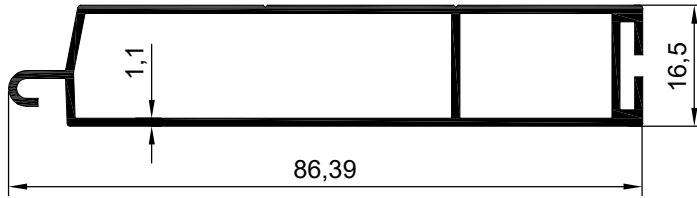

NO : 1954 AGIRLIK : 0,673 kg/m

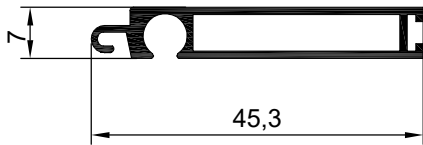

NO : 2173 AGIRLIK : 0,295 kg/m

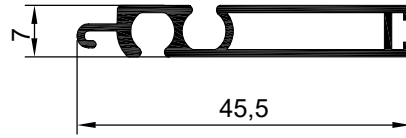

NO : 2170 AGIRLIK : 0,305 kg/m

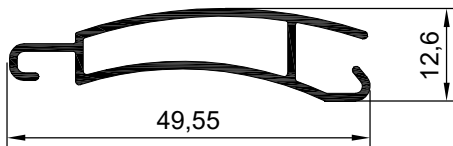

NO : 655 AGIRLIK : 0,319 kg/m

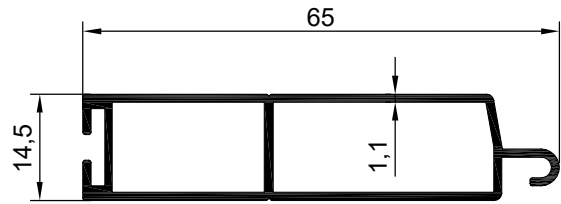

NO:6725 AĞIRLIK: 519 gr/m

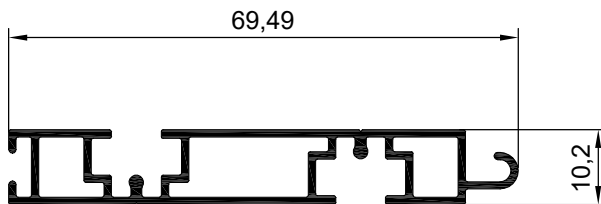

NO : 11262 AGIRLIK : 0,537 kg/m

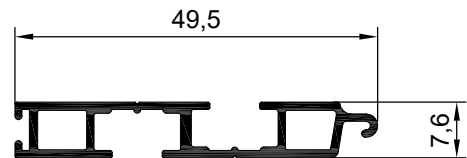

NO : 11263 AGIRLIK : 0,338 kg/m

OTOMOTİK KAPI PROFİLLERİ

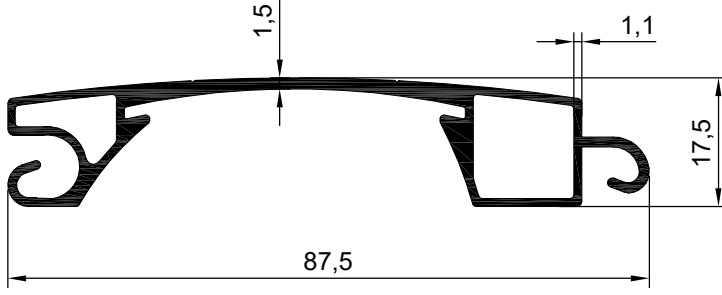

NO : 6247
AĞIRLIK : 759 gr/m

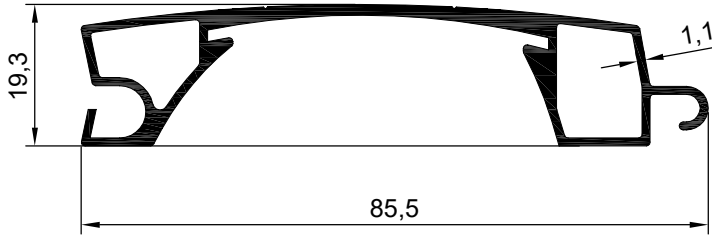

NO : 1951 AĞIRLIK : 0,728 kg/m

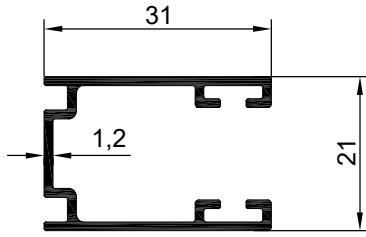

NO :11259 AĞIRLIK : 0,348 kg/m

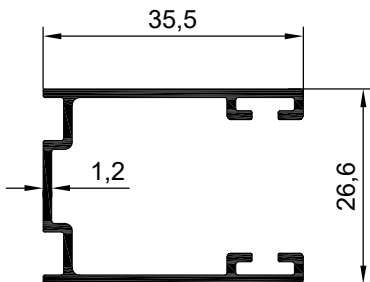

NO :11258 AĞIRLIK : 0,394 kg/m

OTOMOTİK KAPI PROFİLLERİ

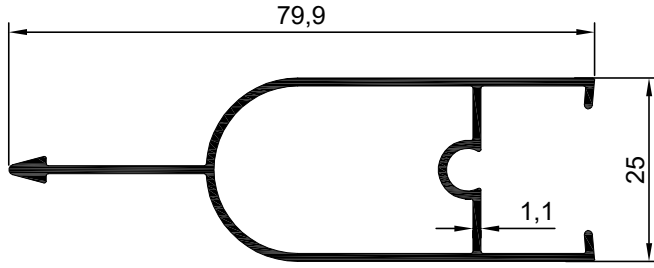

NO : 4822 AGIRLIK : 0,556 kg/m

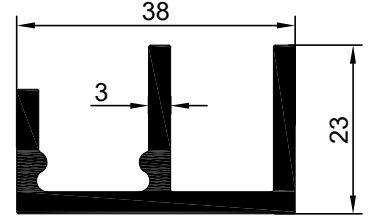

NO : 560
AGIRLIK : 0.760 kg/m

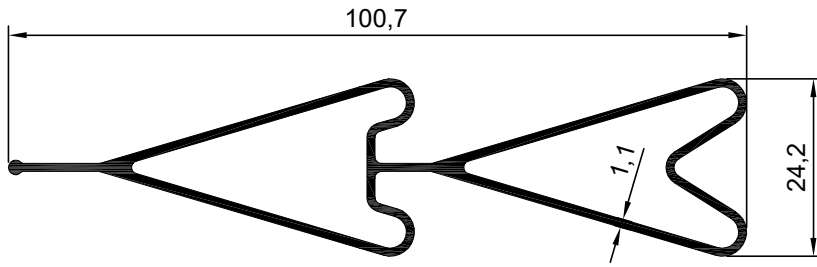

NO : 4823 AGIRLIK : 0,764 kg/m

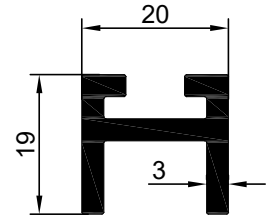

NO : 559
AGIRLIK : 0.470 kg/m

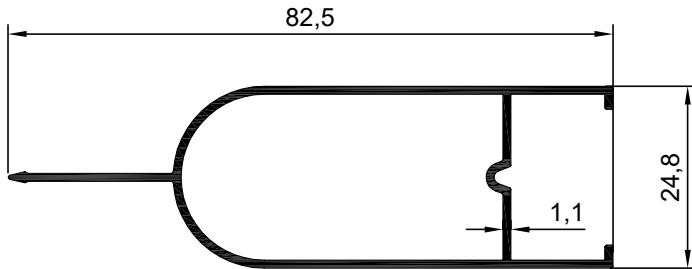

NO : 5234 AGIRLIK : 0,547 kg/m

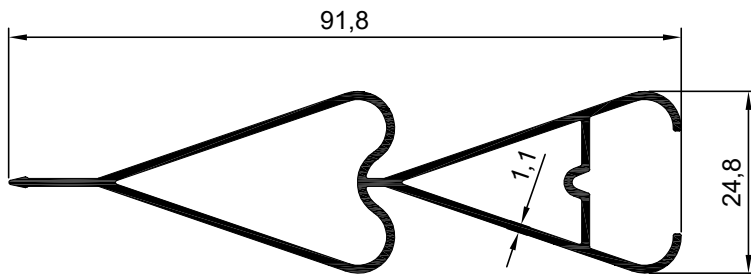

NO : 5233 AGIRLIK : 0,681 kg/m

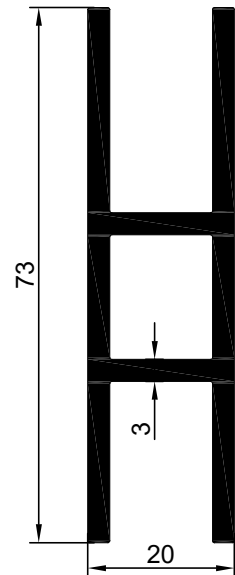

NO : 554
AGIRLIK : 1.409 kg/m

OTOMOTİK KAPI PROFİLLERİ

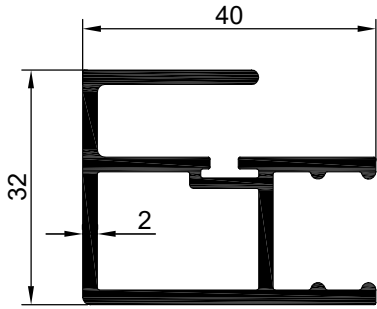

NO : 10860
AGIRLIK : 0.820 kg/m

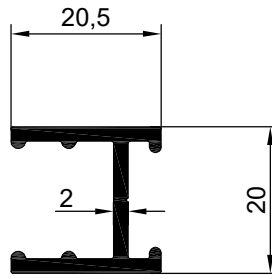

NO : 10865
AGIRLIK : 0.337 kg/m

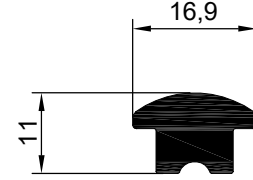

NO : 10866
AGIRLIK : 0.340 kg/m

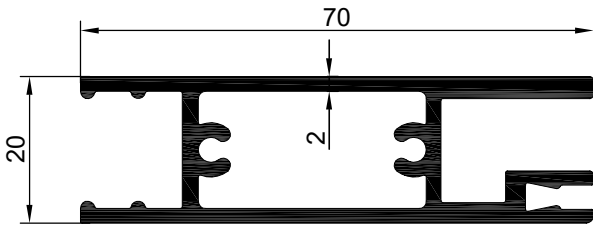

NO : 10861
AGIRLIK : 1.214 kg/m

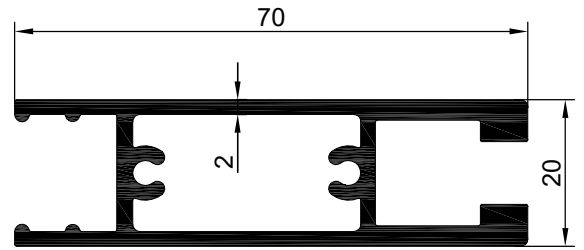

NO : 10862
AGIRLIK : 1.245 kg/m

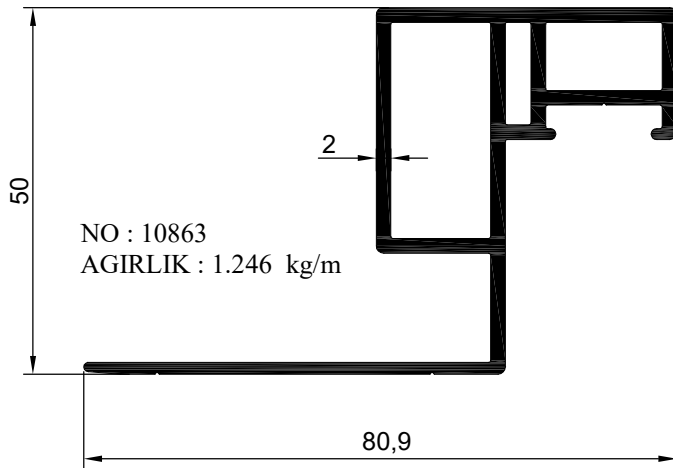

NO : 10863
AGIRLIK : 1.246 kg/m

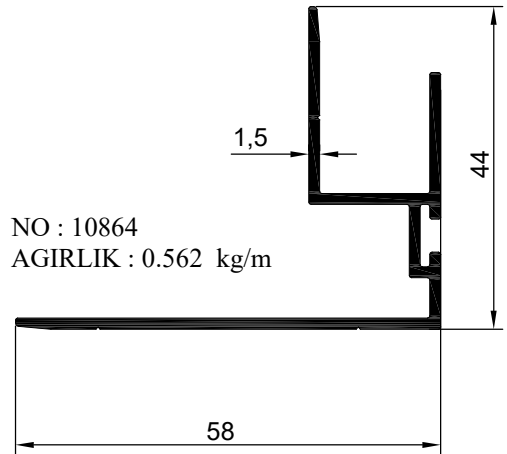

NO : 10864
AGIRLIK : 0.562 kg/m

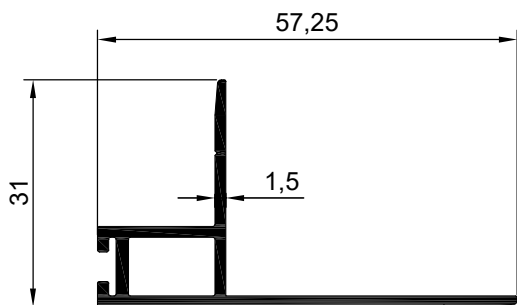

NO : 10869
AGIRLIK : 0.463 kg/m



NO : 10870
AGIRLIK : 0.786 kg/m

OTOMOTİK KAPI PROFİLLERİ

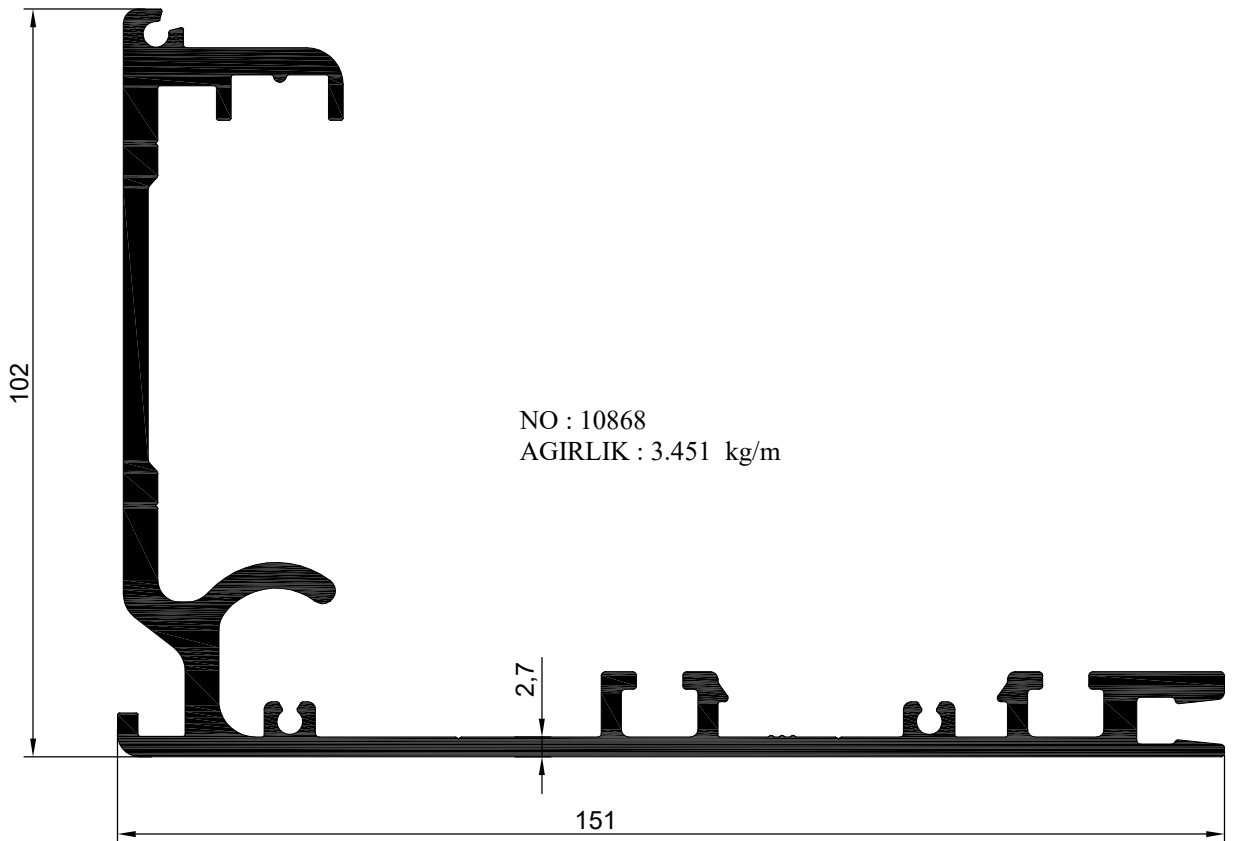
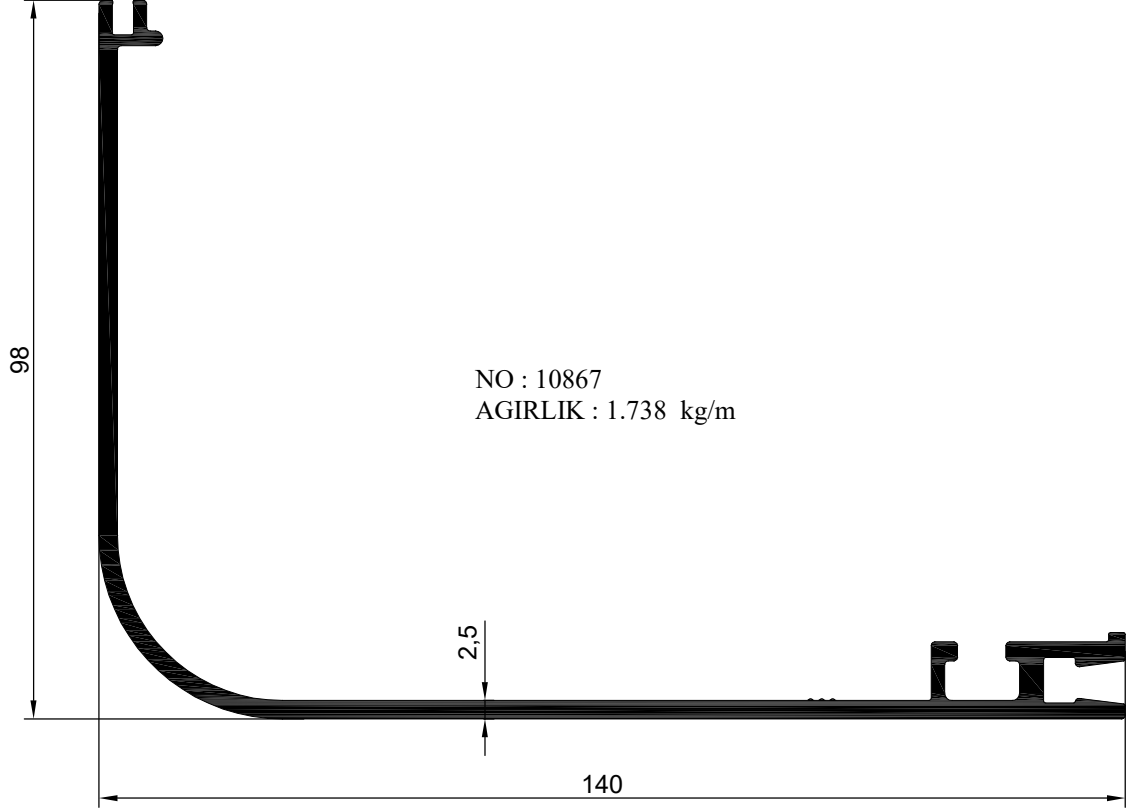

OTOMOTİK KAPI PROFİLLERİ

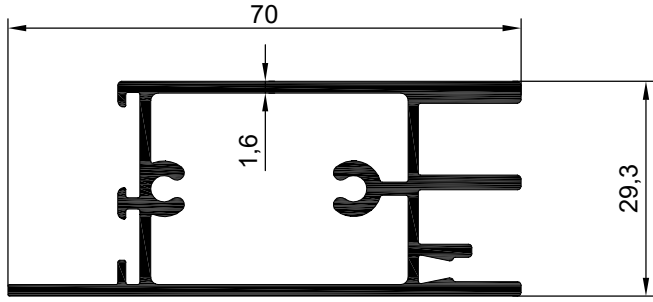

NO : 10871
AGIRLIK : 1.107 kg/m

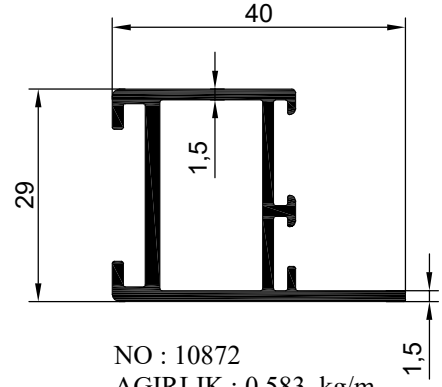

NO : 10872
AGIRLIK : 0.583 kg/m

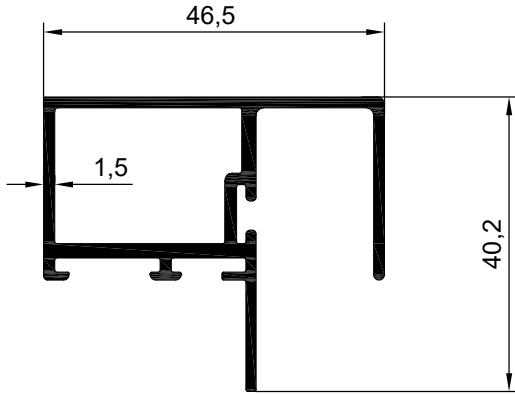

NO : 10873
AGIRLIK : 0.747 kg/m

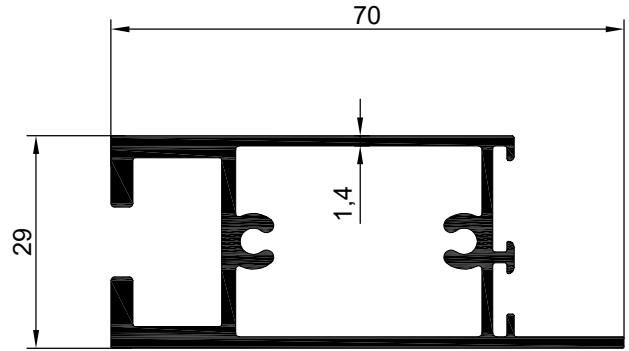

NO : 11179
AGIRLIK : 1.139 kg/m

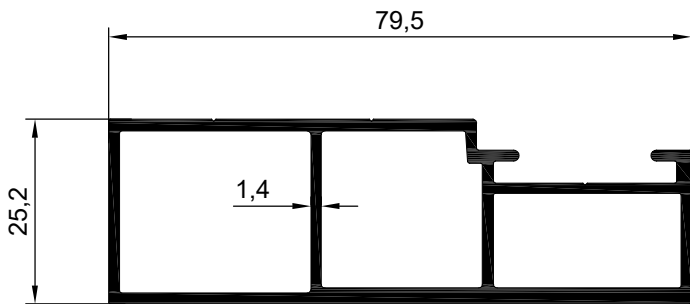

NO :11180 AGIRLIK : 1,107 kg/m

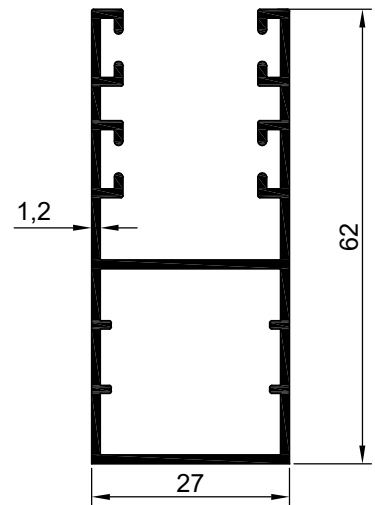

NO :13997 AGIRLIK : 0.713 kg/m

OTOMOTİK KAPI PROFİLLERİ

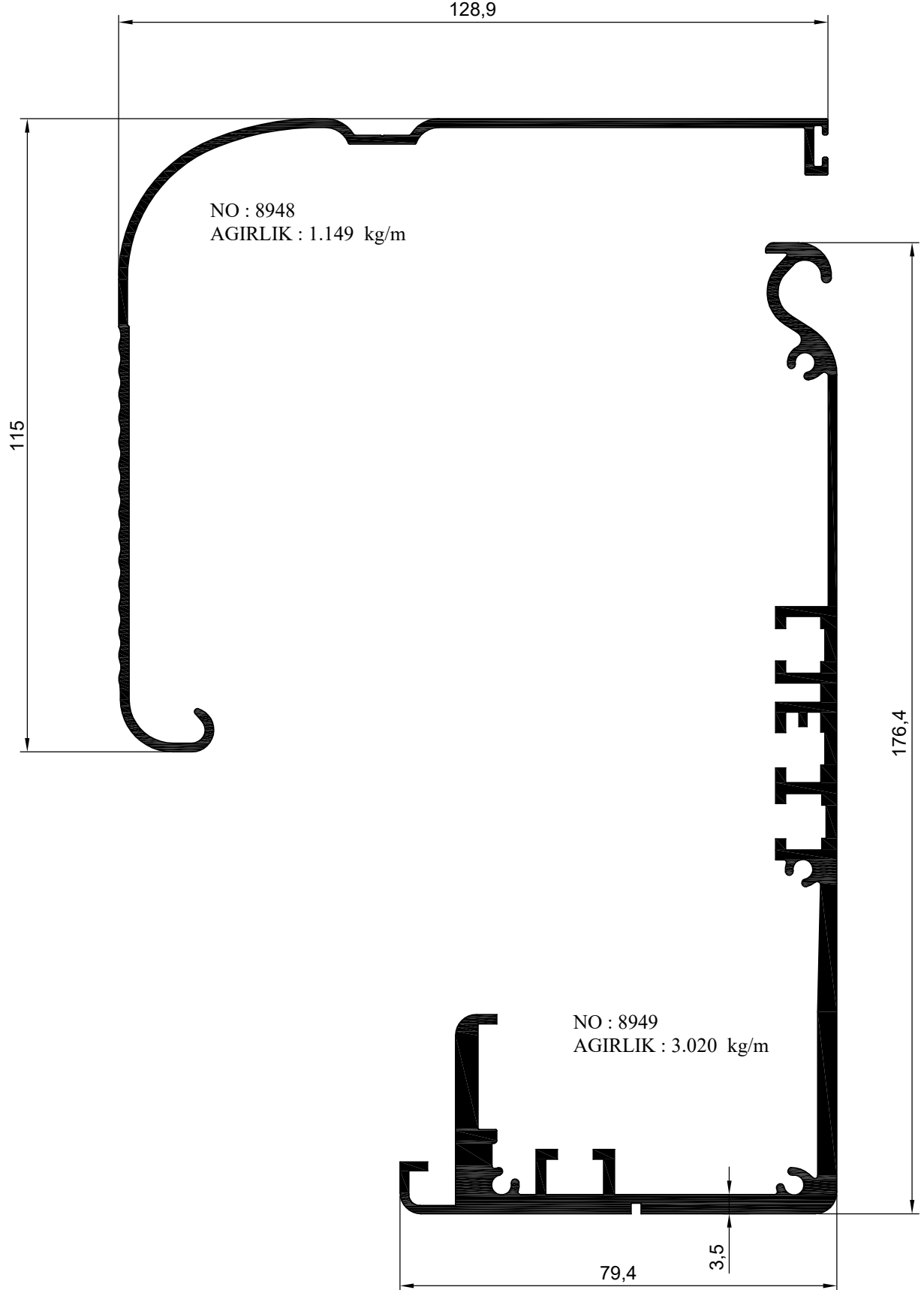

OTOMOTİK KAPI PROFİLLERİ

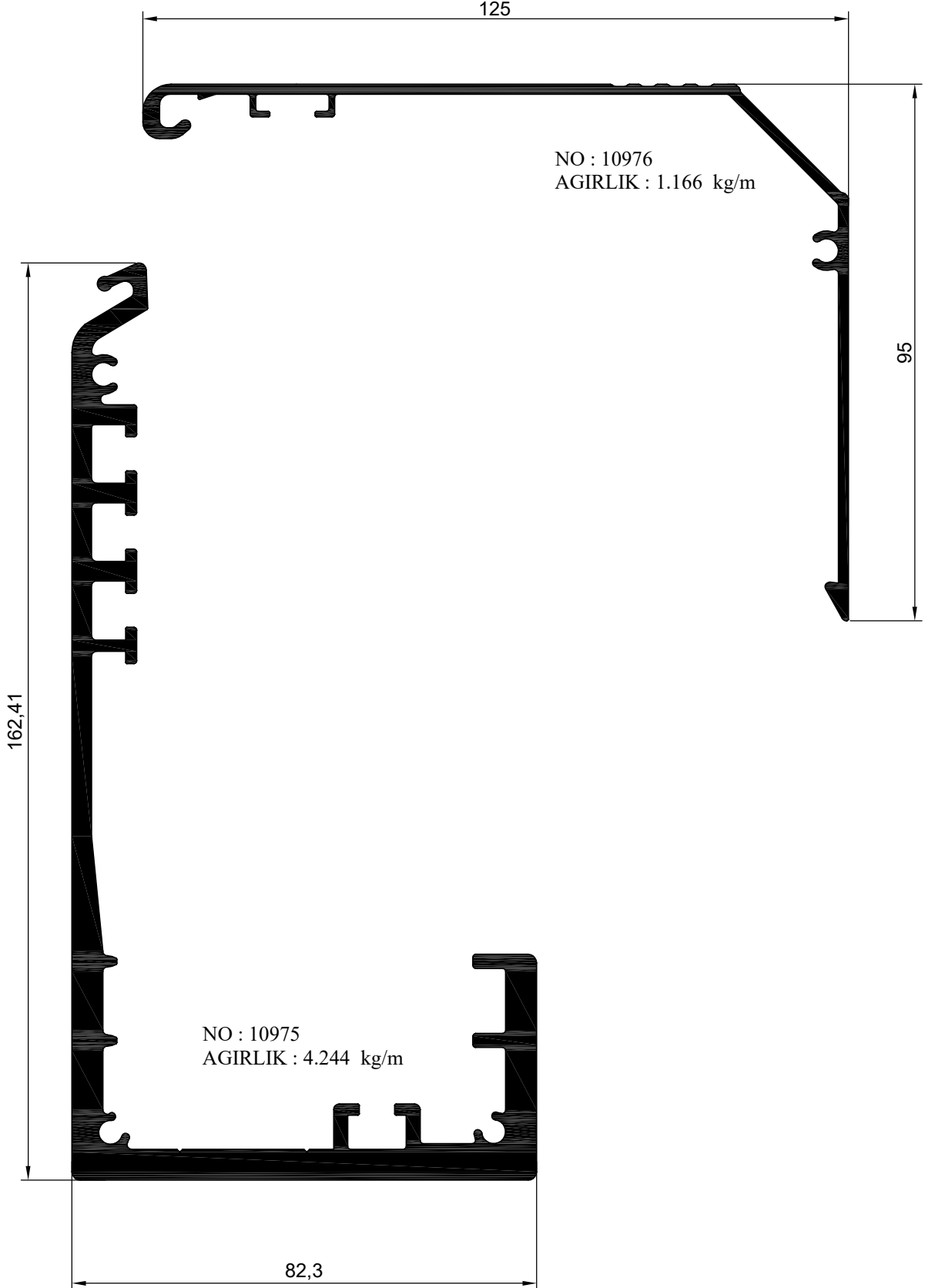

OTOMOTİK KAPI PROFİLLERİ

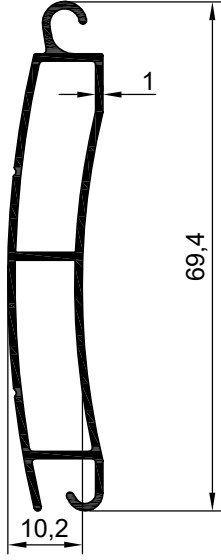

NO : 6066
AĞIRLIK : 0.455 kg/m

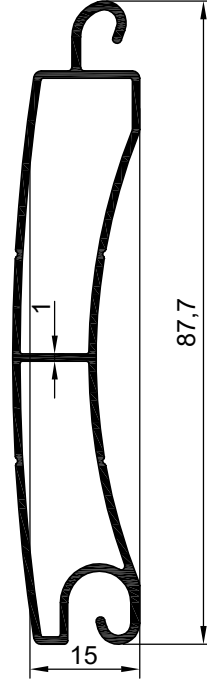

NO : 6067
AĞIRLIK : 0.621 kg/m

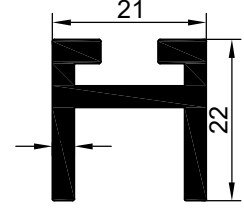

NO : 14160
AĞIRLIK : 0.544 kg/m

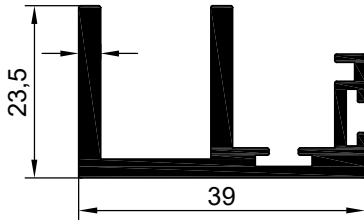

NO : 14161
AĞIRLIK : 0.726 kg/m

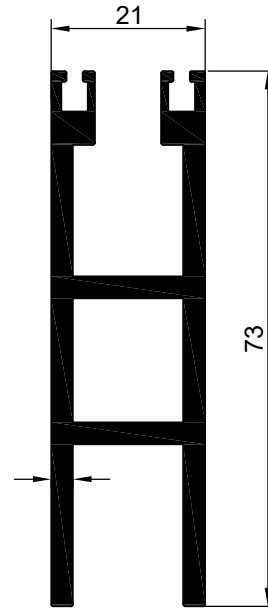

NO : 14162
AĞIRLIK : 1.499 kg/m